



2021

CATÁLOGO • CATALOGUE • CATALOG



Estimado Cliente

Nos es grato poner a su disposición el nuevo catálogo general 2021 de Fepre. En este catálogo podrá encontrar un amplio surtido de productos destinados a la ferretería y el bricolaje.

Para consultar los precios de nuestro Catálogo, recuerde que los artículos están organizados por la página de publicación del Catálogo y ordenados, numéricamente, por Referencia.

Constantemente estamos focalizando nuestros esfuerzos en conseguir su total satisfacción en las áreas servicio, calidad, precio y concepto.

Tenemos un claro objetivo, conseguir que su tienda disponga de los mejores surtidos compuestos por el producto más innovador y con un precio sumamente competitivo.

En Fepre sabemos que todas las tiendas no son iguales, por ello hemos creado múltiples conceptos –plasmados al final de este catálogo– de cada una de nuestras colecciones que sin duda se adaptarán a la superficie y las necesidades de su tienda, rentabilizando al máximo sus implantaciones.

Para que ud pueda gozar de un óptimo servicio Fepre dispone de una superficie superior a los 7.000 m² que nos garantizan disponer de los stocks de producto óptimos para un buen servicio en tasa y plazo de entrega.

Así mismo ponemos a su disposición un equipo humano encabezado por nuestro Director Comercial Josep Ramón Bierge para atenderle y asesorarle.

En Fepre entendemos que su confianza es la base de nuestro constante proceso de expansión y por ello agradecemos que vea en Fepre un proveedor atractivo para su tienda.

Una vez más esperamos estar a la altura de sus expectativas.

Muy atentamente,

Cher Client

Nous fait plaisir de mettre à votre disposition le nouveau Catalogue Général Fepre 2021. Dans ce catalogue, vous trouverez un large assortiment de produits pour la quincaillerie et le bricolage.

Pour consulter les prix de notre catalogue, rappelez-vous que Les articles sont organisés par la page de publication sur le catalogue et classés, numériquement, par Référence

Nous sommes constamment concentrés sur la réalisation de votre satisfaction dans les zones de service, qualité, prix et le concept. Nous avons un objectif clair: obtenir pour votre magasin le meilleur assortiment constitué par le produit le plus innovant et à un prix très compétitif.

A Fepre nous connaissons que tous les magasins ne sont pas égales. C'est pour ça que nous avons développé, pour chacune de nos collections, une multitude de concepts, qui sont exposées à la fin de ce catalogue. Bien sûr, quelqu'une sera approprié à la surface et les besoins de votre magasin et elles feront rentabiliser au maximum vôtres implémentations.

Pour offrir le meilleur service, Fepre a une superficie de plus de 7000 m². Cela garantit que nous avons un stock suffisant de produits pour donner un bon service à la fois de taxe de service et de livraison.

Nous disposons également d'une équipe dirigée par notre Directeur Commercial, Josep Ramon Bierge, pour vous aider et conseiller à tout moment.

À Fepre nous savons que votre confiance est la base de notre constant processus d'expansion et pour cette raison nous vous remercions de voir en Fepre un fournisseur attractif pour votre magasin.

Une fois encore, nous attendons être à la hauteur de vos attentes.

Bien à vous,

Dear Customer

We are pleased to make available the new 2021 General Catalog of Fepre.

In this catalog you will find a wide assortment of products for hardware and DIY.

To consult the prices of our Catalog, remember that the articles are organized by the publication page of the Catalog and sorted, numerically, by Reference.

We are constantly focusing our efforts on achieving your satisfaction in the service areas, quality, price and concept.

We have a clear goal, to get your store has the best assortment consisting of the most innovative product and a very competitive price.

In Fepre know that all stores are not equal, so we have created multiple concepts-reflected at the end of this catalog, each of our collections that will undoubtedly surface and adapted to the needs of your store, making the most their implementations.

For ud can enjoy an excellent service Fepre has an area over 7,000 m² guarantee we have the best product stocks for good service and delivery rate.

Also we offer a team headed by our Sales Director Josep Ramon Bierge to assist and advice.

In Fepre understand that your trust is the foundation of our constant process of expansion and so grateful that you see in Fepre an attractive supplier for your store.

Once again we hope to live up to your expectations.

Sincerely,

Eduardo Coloma,
Director General / Consejero Delegado
Directeur Général / General Manager
FERRETERÍA Y PRENSAS, S.A.



ÍNDICE DE PRODUCTOS · INDEX DES PRODUITS · INDEX OF PRODUCTS

Rejillas de Ventilación

Grilles d'aération

Ventilation Grilles

- Rejillas de aluminio
- Rejillas reforzadas
- Luxair
- Rejillas con copa y difusores
- Entradas de aire
- Rejillas de ABS
- Aeroventiladores función mecánica
- Tapas de registro
- Compuertas para animales

- Grilles en alu
- Grilles renforcées
- Luxair
- Grilles avec dôme et diffuseurs
- Entrées d'air
- Grilles ABS
- Aérateurs a lamelles
- Trappes de visite
- Chatières

- Aluminium grilles
- Reinforced grilles
- Luxair
- Grilles with dome and diffusers
- Window and door ventilation
- ABS grilles
- Mechanical air ventilators
- Revision hatch door
- Gates for small pets

14 - 19
20 - 21
22 - 23
24 - 25
26
27 - 35
36
36
37

Extractores y Accesorios de aireación

Extracteurs et Accessoires d'aération

Extractors and Ventilation Accessories

- Extractores
- Accesorios de extracción
- Sistemas extracción de humos

- Extracteurs
- Accessoires d'extraction
- Systemes d'extraction de desenfumage

- Extractors
- Extraction accessories
- Smoke extraction systems

40 - 43
44 - 45
46 - 49

Soportes Electrodomésticos

Supports électroménagers

Appliances brackets

- Soportes TV
- Adaptador VESA
- Soportes microondas
- Soportes Smartphone y tablet

- Supports TV
- Adaptateur VESA
- Supports micro-ondes
- Supports Smartphone et tablet

- TV Supports
- VESA Adaptor
- Microwave brackets
- Smartphone and tablet Supports

52 - 56
56
57
58 - 59

Soportes y escuadras

Supports et Équerres

Wall Mounts and Brackets

- Escuadras de acero funcionales
- Escuadras infantiles
- Soportes radiador
- Escuadras acero ornamentales
- Escuadras madera
- Escuadras decorativas de acero

- Équerres d'acier fonctionnelles
- Équerres infantiles
- Supports appareil radiateur
- Équerres ornementaux
- Équerres en bois
- Équerres decoratives d'acier

- Wall mounts and brackets
- Children's brackets
- Radiator mounts
- Ornamental steel brackets
- Wooden brackets
- Decorative steel brackets

62 - 66
67
67
68
69
70 - 71

Estantes y clips

Tablettes et Clips

Shelving and shelf lock clips

- Clips para estantes HomeDecor
- Estantes de cristal HomeDecor
- Estantes de madera HomeDecor
- Estantes de fijación invisible HomeDecor

- Clips pour tablettes HomeDecor
- Tablettes en verre HomeDecor
- Tablettes en bois HomeDecor
- Tablettes avec fixation invisible HomeDecor

- Clips for HomeDecor shelving
- HomeDecor glass shelving
- HomeDecor wooden shelving
- HomeDecor invisible mounted invisible fastening

74
75
76
77 - 82

Sistema de agarre TWIST

Système de prise TWIST

Gripping System TWIST

- Gama Twist

- Gamme Twist

- Twist Range

84

Guías y cartelas/Hogar

Montants et consoles/Maison

Rail guides and brackets/ home

- Guías y cartelas
- Tenderos extensibles
- Organizadores para nevera

- Montants et consoles
- Sechoirs a ligne extensibles
- Organisations pour frigo

- Rail guides and brackets
- Drying area extensibles
- Fridge organizers

86 - 87
88
89

Patas para muebles

Pieds pour meubles

Legs for furniture

- Patas para muebles

- Pieds pour meubles

- Legs for furniture

92 - 93

Protección vehículos

Protection voiture

Vehicles protectors

- Protectores de Vehículos

- Protection voiture

- Vehicle protectors

96 - 97

Implantaciones

Implantations

Implantations

- Rejillas de ventilación
- Extractores, tubos y accesorios
- Escuadras funcionales y semidecorativas
- Soportes electrodomésticos
- Clips, escuadras decorativas y estantes de madera y cristal
- Estantes de fijación invisible
- Guías y cartelas
- Patas para muebles

- Grilles d'aération
- Extracteurs, tubs et accessoires
- Équerres fonctionnels et semi-decoratives
- Supports électroménagers
- Clips, Équerres décoratives, tablettes en verre et bois
- Tablettes de fixation invisible
- Guides et supports
- Pieds pour meubles

- Ventilation grilles
- Extractors, piping and accessories
- Functional and semi-decorative brackets
- Electrical appliance wall mounts
- Locks clips, decorative brackets and wooden and glass shelves
- Invisible mounted shelving
- Guide rails and brackets
- Legs for furniture

100 - 105
106 - 112
113 - 117
118 - 120
121 - 125
126 - 132
133 - 136
137 - 138

Esquema-guía para la interpretación de este catálogo

Schéma-guide pour l'interprétation du catalogue
Scheme-guide to the interpretation of this catalogue

Empotrables · Encastrer · Built-in

Multidiámetro. Lamas Móviles · Multi diamètre. Volets mobiles · Multidiameter. Movable planks.

Subcategoría
Sous-catégorie
Subcategory

Descripción del artículo
Description article
Item description

Color / Acabado
Couleur / fini
Colour / Finished

Referencia
Référence
Reference



Características técnicas
Caractéristiques techniques
Technical characteristics

Información sobre la presentación del producto
Information sur la présentation des produits
Information about product presentation

Información sobre prestaciones del producto
Information sur les prestations du produit
Product benefits information

Imágenes del producto
Image du Produit
Product Pictures

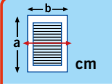
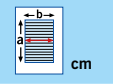
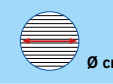
041416

 cm	 cm	 Ø cm	 cm ²
15 x 15	55 x 11	10 y 12	47

5 

NOVEDAD EN ESTE CATÁLOGO · NOUVEAU DANS CE CATALOGUE · NEW IN THIS CATALOG

028868

Nuevos productos catálogo 2021

Catalogue des nouveaux produits 2021
New products catalog 2021

Esquema-guía para la interpretación de la tarifa

Schéma-guide pour l'interprétation de la tarifa
Scheme-guide to the interpretation of list price

Rejillas de ventilación · Grilles d'aération · Ventilation grilles

Familia de productos

Famille produit
Product family

Página de publicación del producto

Page de publication du produit
Product publication page

EAN = 8421272 + REF

Unidades de venta en embalaje primario

Unités de vente sur l'emballage primaire
Product benefits information

PAG	REF	EAN	UE	€
PAG 25	051235	8421202051235	5	4,25

Referencia publicada en el catálogo

Référence publié dans le catalogue
Reference published in the catalog

Precio unitario

Prix unitaire
Unit price

Usted encontrará los precios de nuestros productos en el anexo "TARIFA". Los artículos están organizados por la página de publicación del Catálogo y ordenados, numéricamente, por Referencia.







Vous trouverez les prix de nos produits à l'annexe « TARIF ». Les articles sont organisés par la page de publication sur le catalogue et classés, numériquement, par Référence

You will find the prices of our products in the annex "RATE". The articles are organized by the publication page of the Catalog and sorted, numerically, by Reference

Pictogramas de información sobre la presentación del producto

Pictogrammes d'information sur la présentation des produits











Information pictograms about product presentation

	Unidad de embalaje Unités d'emballage Packing		Colgador incluido Crochet inclus Hanger included		Presentación en bolsa Présenté en sac Bag pack presentation
	Incluye código EAN Inclut code EAN Includes EAN code		Presentación en blister Présenté en blister Blister pack presentation		Cantoneras de protección incluidas Coins de protection compris Protective corner including

Pictogramas de información sobre las prestaciones del producto

Pictogrammes d'information sur les prestations du produit

Information pictograms about product performances

	Con mosquitera protectora de insectos Avec moustiquaire protecteur d'insectes With protective insects net		Incluye tornillos de instalación Comprend les vis de montage Includes mounting screws		Eje de orientación horizontal Orientation de l'axe horizontal Horizontal orientation axis
	Montaje de superficie Montage de surface Surface Mount		Interruptor "standard" Interrupteur "standard" standard switch		Doble eje de orientación horizontal Double orientation de l'axe horizontal Double axis horizontal orientation
	Montaje empotrable Montage a encastrer Flush mounting		Interruptor por cuerda Interrupteur a tirette Pull cord switch		Triple eje de orientación horizontal Triple axe d'orientation horizontal triple axis horizontal orientation
	Montaje empotrable a tubo montage a encastrer a tube Built-in tube mounting		Controlador de humedad Capteur d'humidité Humidity sensor		Giro de orientación de 360° Virement d'orientation de 360 ° 360 ° Rotation
	Paso de aire regulable Débit d'air réglable Adjustable airflow		Temporizador Temporisateur Timer		Nivelación horizontal Alignement horizontal Horizontal alignment
	Caudal de aire Flux d'air Airflow		Válvula antiretorno Tout clapet de retour Any return valve		Inclinable Basculant Tilted
	Montaje mediante adhesivo Montage avec adhésif Assembly using glue		Orientación vertical Réglage vertical Vertical orientation		Articulable Articulée Articulated
	Montaje mediante tornillos Montage avec vis Screw mounting		Brazo extensible Bras extensible Extendible Arm		Extensible Extensible Extendible



50 AÑOS DE CALIDAD Y SERVICIO

En 1.969, **Fepre** inició su actividad en el mercado del bricolaje y gracias a la confianza depositada por parte de nuestros clientes, hoy podemos afirmar que nuestra firma está presente en la gran mayoría de las grandes y pequeñas cuentas del sector nacional y europeo. La Central ubicada en Rubí (Barcelona) con una superficie de más de 7.000 m² alberga una moderna fábrica totalmente automatizada. Los almacenes cuentan con una capacidad de estocaje para más de 4.000 palets que garantizan disponer de los stocks de producto óptimos para desarrollar un buen servicio en tasa y plazos de entrega. A su disposición un catálogo de productos con más de 1.500 referencias ubicadas siempre en el sector ferretería - bricolaje. Ilusión, nuevas ideas, búsqueda de nuevas tendencias: Estos son nuestros valores.

En **Fepre**, seguiremos trabajando día a día para que su tienda disponga de los mejores surtidos compuestos por el producto más innovador y con un precio sumamente competitivo.



50 ANS DE QUALITÉ ET DE SERVICE

En 1969, a commencé l'activité de **Fepre** sur le marché du bricolage et grâce à la confiance mis par nos clients à Fepre, nous pouvons dire aujourd'hui que notre Société est présent dans la majorité des petits et grands comptes du secteur du Bricolage national et européen. Notre Siege Centrale, situé à Rubí (Barcelone). avec une surface de plus de 7.000 m² abrite une usine moderne entièrement automatisé. Nos entrepôts ont une capacité de plus de 4.000 palettes de stockage et nous permettent d'assurer le stock de produit optimale pour développer la meilleure prestation de services et taux de livraison. Nous offrons une gamme de produits avec plus de 1.500 références toujours situées dans le secteur de la quincaillerie et bricolage.

Illusion, des nouvelles idées, et recherche de nouvelles tendances. Ces sont nos valeurs.

En **Fepre**, nous allons a continuer à travailler chaque jour pour votre magasin afin d'offrir les meilleurs assortiments et le produit le plus innovateur et à un prix très compétitif.



50 YEARS OF QUALITY AND SERVICE

In 1969 **Fepre** began its market activity in the DIY sector and thanks to the enormous vote of confidence **Fepre** has received from its customers, we can now say that our company is present in most of the large and smaller sector accounts in Spain and the rest of Europe. Our headquarters in Rubí (Barcelona), with a surface area of over 7,000m², house a totally automated cutting-edge factory. Our warehouses have a stocking capacity for over 4,000 pallets, affording us optimum product stockage so we can provide excellent service in terms of rates and delivery times.

We can offer you a product portfolio of over 1,500 items exclusively for the hardware and DIY sector.

Aspiration, new ideas, the search for new trends: These are our values. At **Fepre** we work hard every day to make sure your store has the best selection of the most innovative products at highly competitive prices.





**NUESTROS PRODUCTOS
EN LOS MERCADOS DEL
BRICOLAJE INTERNACIONAL**



**NOS PRODUITS SUR LES
MARCHÉS DU BRICOLAGE
INTERNATIONAL**



OUR PRODUCTS IN
THE INTERNATIONAL
DIY MARKET

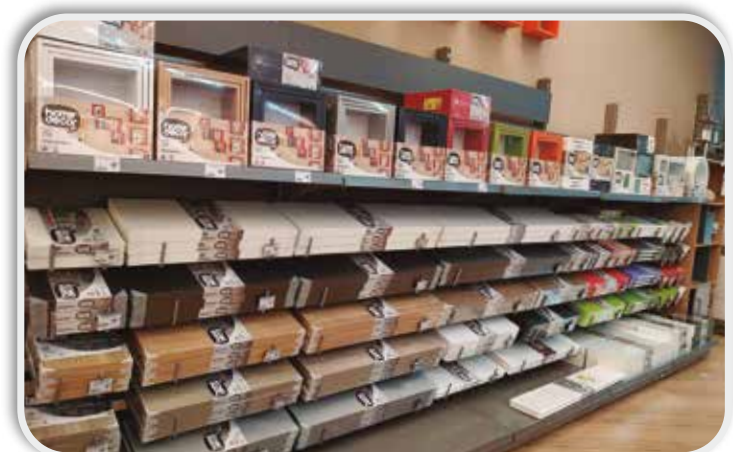

PRESENCIA EN FERIAS Y EVENTOS

Durante años hemos participado en las Ferias más importantes del Sector del Bricolaje, donde pudimos contactar directamente con Distribuidores y Grandes Cuentas de todo el mundo.



Las Vegas

National Hardware Show
Las Vegas 2015



International
Hardware
Colonia 2014

PRÉSENCE EN FOIRES ET SALONS

Pendant des années, nous avons participé à des foires les plus importantes du secteur du bricolage, où nous avons pu contacter directement avec Distributeurs et les Grands Comptes de toute le monde.



International Hardware
Colonia 2012

Colonia

International Trade Fair
Dubai 2012



Brico & Habitat International Exhibition
Paris 2011



Eurobrico Meeting Point
Valencia 2008



FEPRE AT TRADE FAIRS AND EVENTS

For years we have participated in the most important fairs of the DIY sector, where we could contact directly with distributors and Large Account worldwide.

Ferroforma International Exhibition
Bilbao 2004

REJILLAS DE VENTILACIÓN GRILLES D'AÉRATION VENTILATION GRILLES



Rejillas de Aluminio
Grilles en Alu
Aluminium Grilles

000000 Ref.
Codigo EAN = 8421272 + Ref.

Cuadradas · Carrées · Square



A x B cm	A x B cm²	mm											
		0,6	0,8	0,6	0,8	0,8	0,8	0,8	0,8	0,6	0,6	0,8	0,8
		ALU	ALU	Bianco Blanc White	Bianco Blanc White	Plata mate Argent mat Matt Silver	Oro Or Gold	Bronce Bronze Bronze	Haya Hêtre Beech	Wenge	Ladrillo Brique Brick	Negro Noire Black	
10 x 10	25	053303	053563	053433	053693	053822	053952	054089	054218	054348	054478	056205	
15 x 15	60	053334	053594	053464	053723	053853	053983	054119	054249	054379	054508	056229	
17 x 17	150	053358	053617	053488	053747	053877	054003	054133	054263	054393	054522	056243	
20 x 20	95	053372	053631	053501	053761	053891	054027	054157	054287	054416	054546	056250	
25 x 25	150	053402	053662	053532	053792	053921	054058	054188	054317	054447	054577		
30 x 30	240	053426	053686	053556	053815	053945	054072	054201	054331	054461	054591		



Rectangulares · Rectangulaire · Rectangulars



A x B cm	A x B cm²	mm											
		0,6	0,8	0,6	0,8	0,8	0,8	0,8	0,8	0,6	0,6	0,8	0,8
		ALU	ALU	Bianco Blanc White	Bianco Blanc White	Plata mate Argent mat Matt Silver	Oro Or Gold	Bronce Bronze Bronze	Haya Hêtre Beech	Wenge	Ladrillo Brique Brick	Negro Noire Black	
10 x 20	50	053310	053570	053440	053709	053839	053969	054096	054225	054355	054485	056212	
20 x 10v	50	053365	053624	053495	053754	053884	054010	054140	054270	054409	054539		
10 x 30	66	053327	053587	053457	053716	053846	053976	054102	054232	054362	054492		
20 x 30	128	053389	053648	053518	053778	053907	054034	054164	054294	054432	054563		
20 x 40	183	053396	053655	053525	053785	053914	054041	054171	054300	054430	054560		
15 x 30	80	053341	053600	053471	053730	053860	053990	054126	054256	054386	054515		
30 x 15v	80	053419	053679	053549	053808	053938	054065	054195	054324	054454	054584		





Rejillas de Aluminio con gancho

Grilles en Alu avec crochet

Aluminium Grilles whit hook

Cuadradas · Carrées · Square



 A x B cm ²	0,6		0,8		0,8		0,8		0,6		0,8	
	ALU	ALU	Blanco Blanc White	Blanco Blanc White	Plata mate Argent mat Matt Silver	Oro Or Gold	Bronce Bronze Bronze	Haya Hêtre Beech	Wenge	Ladrillo Brique Brick	Negro Noire Black	
10 x 10	25	001502	001625	001403	002349	001748	001861	001984	002585	008471	006316	003650
15 x 15	60	001571	001694	001472	002417	001816	001939	002059	002653	008549	006385	003674
17 x 17	150	001601	001724	001397	002448	001847	001960	002080	006484	008594	006415	003698
20 x 20	95	001540	001663	001441	002387	001786	001908	002028	002622	008518	006354	003704
25 x 25	150	002479	002950	002462	002967	002974	002981	002998	002486	008464	006422	
30 x 30	240	001618	001731	001359	002455	001854	001977	002097	002691	008570	006439	



Rectangulares · Rectangulaire · Rectangulars



 A x B cm ²	0,6		0,8		0,8		0,8		0,6		0,8	
	ALU	ALU	Blanco Blanc White	Blanco Blanc White	Plata mate Argent mat Matt Silver	Oro Or Gold	Bronce Bronze Bronze	Haya Hêtre Beech	Wenge	Ladrillo Brique Brick	Negro Noire Black	
10 x 20	50	001519	001632	001410	002356	001755	001878	001991	002592	008488	006323	003667
20 x 10	50	001526	001649	001427	002363	001762	001885	002004	002608	008495	006330	
10 x 30	66	001533	001656	001434	002370	001779	001892	002011	002615	008501	006347	
20 x 30	128	001557	001670	001458	002394	001793	001915	002035	002639	008525	006361	
20 x 40	183	001564	001687	001465	002400	001809	001922	002042	002646	008532	006378	
15 x 30	80	001588	001700	001489	002424	001823	001946	002066	002660	008556	006392	
30 x 15v	80	001595	001717	001496	002431	001830	001953	002073	002677	008563	006408	



Rejillas de Aluminio e Inox con mosquitera
Grilles Alu et Inox avec moustiquaire
Aluminium and Stainless Steel grilles

000000 Ref.
Codigo EAN = 8421272 + Ref.



Cuadradas · Carrées · Square

A x B cm	cm ²	0,6		0,8		0,8		0,8		0,6		0,5	
		ALU	ALU	Blanco Blanc White	Blanco Blanc White	Plata mate Argent mat Matt Silver	Oro Or Gold	Bronce Bronze Bronze	Haya Hêtre Beech	Wenge	INOX SUS 430		
10 x 10	25	054706	054966	054836	055123	055284	055444	055604	055765	055925	056052		
15 x 15	60	054737	054997	054867	055154	055314	055475	055635	055796	055956	056083		
17 x 17	150	054751	055017	054881	055178	055338	055499	055659	055819	055970	056120		
20 x 20	95	054775	055031	054904	055192	055352	055512	055673	055833	055994	056106		
25 x 25	150	054805	055062	054935	055222	055383	055543	055703	055864	056021	056137		
30 x 30	240	054829	055086	054959	055246	055406	055567	055727	055888	056045	-		

Rectangulares · Rectangulaire · Rectangulars

A x B cm	cm ²	0,6		0,8		0,8		0,8		0,6		0,5	
		ALU	ALU	Blanco Blanc White	Blanco Blanc White	Plata mate Argent mat Matt Silver	Oro Or Gold	Bronce Bronze Bronze	Haya Hêtre Beech	Wenge	INOX SUS 430		
5 x 15	13				055093	055253	055413	055574	055734	055895			
5 x 25	25				055109	055260	055420	055581	055741	055901			
5 x 40	44				055116	055277							
10 x 20	50	054713	054973	054843	055130	055291	055451	055611	055772	055932	056069		
20 x 10v	50	054768	055024	054898	055185	055345	055505	055666	055826	055987			
10 x 30	66	054720	054980	054850	055147	055307	055468	055628	055789	055949			
20 x 30	128	054782	055048	054911	055208	055369	055529	055680	055840	056007			
20 x 40	183	054799	055055	054928	055215	055376	055536	055697	055857	056014			
15 x 30	80	054744	055000	054874	055161	055321	055482	055642	055802	055963			
30 x 15v	80	054812	055079	054942	055239	055390	055550	055710	055871	056038			



USO PROFESIONAL
USAGE PROFESSIONAL
PROFESSIONAL USE



Pack 30 rejillas · Pack 30 grilles · Pack 30 grilles



A x B cm	cm ²	0,6
		Blanco Blanc White
15 x 15	60	005715
20 x 20	95	005708





Cuadradas · Carrées · Square

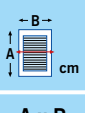

		0,6	0,8	0,6	0,8	0,8	0,8	0,8	0,6	0,6	0,5	
		ALU	ALU	Blanco Blanc White	Blanco Blanc White	Plata mate Argent mat Matt Silver	Oro Or Gold	Bronce Bronze Bronze	Haya Hêtre Beech	Wenge	INOX SUS 430	
A x B	cm²											
10 x 10	25	008204	003773	005869	002714	002103	002226	002837	003896	008617	040471	
15 x 15	60	008273	003841	005937	002783	002172	002295	002905	003964	008693	040495	
17 x 17	150	008303	003872	005968	002813	002202	002325	002936	002523	008730	041553	
20 x 20	95	008242	003810	005906	002752	002141	002264	002875	003933	008655	040488	
25 x 25	150	008310	002493	005975	002509	002554	002516	002547	002530	008600	041546	
30 x 30	240	008327	003889	005982	002820	002219	002332	002943	003995	008723	-	

Rectangulares · Rectangulaire · Rectangulars



		0,6	0,8	0,6	0,8	0,8	0,8	0,8	0,6	0,6	0,5	
		ALU	ALU	Blanco Blanc White	Blanco Blanc White	Plata mate Argent mat Matt Silver	Oro Or Gold	Bronce Bronze Bronze	Haya Hêtre Beech	Wenge	INOX SUS 430	
A x B	cm²											
5 x 15	13				040259	040068	040310	040112	041584	041560		
5 x 25	25				040266	040075	040327	040129	041591	041577	040211	
5 x 40	44				040273	040082						
10 x 20	50	008211	003780	005876	002721	002110	002233	002844	003902	008624	040525	
20 x 10v	50	008228	003797	005883	002738	002127	002240	002851	003919	008631		
10 x 30	66	008235	003803	005890	002745	002134	002257	002868	003926	008648		
20 x 30	128	008259	003827	005913	002769	002158	002271	002882	003940	008662		
20 x 40	183	008266	003834	005920	002776	002165	002288	002899	003957	008679		
15 x 30	80	008280	003858	005944	002790	002189	002301	002912	003971	008709		
30 x 15v	80	008297	003865	005951	002806	002196	002318	002929	003988	008716		



Rejillas de Aluminio
Grilles en Alu
Aluminium Grilles

000000 Ref.
Codigo EAN = 8421272 + Ref.



Empotrables · À encastrer · Built-in

Standard

A x B	A x B	cm ²	mm				
			0,6	0,8	0,6	0,8	0,8
17 x 16,5	14,2 x 15	150	ALU	ALU	Blanco Blanc White	Blanco Blanc White	Plata mate Argent mat Matt Silver
22 x 11,5	19x10	49		004015		004213	004060
22 x 21,5	19 x 20	120		004022		004220	004077



- Entran a presión. No necesitan tornillos.
- Sous pression. Sans Vis.
- Pressure inserted. No screws required.

DECOR

A x B	A x B	cm ²	mm			
			1,5	1,5	1,5	1,5
8 x 30	6,6 x 28	56	Blanco Blanc White	Plata mate Argent mat Matt Silver	Negro Noire Black	Oro Or Gold
8 x 50	6,6 x 48	109	028813	028790	028875	040358



- Rejilla decorativa para microondas, hornos empotrados, frigoríficos, etc. Entran a presión. No necesitan tornillos.
- Grille Déco spéciale micro-ondes, fours encastrés, réfrigérateurs, etc. Sous pression. Sans Vis.
- Decorative grille for microwaves, built-in ovens, fridges, etc. Pressure inserted. No screws required.

DECOR VINTAGE

A x B	A x B	cm ²	mm	
			1,5	1,5
8 x 30	6,6 x 28	43	Blanco Blanc White	Plata mate Argent mat Matt Silver
			046510	046534



- Rejilla decorativa para microondas, hornos empotrados, frigoríficos, etc. Entran a presión. No necesitan tornillos.
- Grille Déco spéciale micro-ondes, fours encastrés, réfrigérateurs, etc. Sous pression. Sans Vis.
- Decorative grille for microwaves, built-in ovens, fridges, etc. Pressure inserted. No screws required.

Rejillas de Aluminio
Grilles en Alu
Aluminium Grilles



Regulables · Réglables · Adjustables

A x B cm	cm ²	0,8	0,8	0,8	0,8
		mm	mm	mm	mm
		ALU	Blanco Blanc White	Plata mate Argent mat Matt Silver	Oro Or Gold
4'5 x 24	0 - 18		040297	040099	040365
7 x 24	0 - 39		040303	040105	040372
17 x 13	0 - 56	004510	004718	004565	004619
17 x 19	0 - 89	004527	004725	004572	004626
17 x 25	0 - 123	004534	004732	004589	004633

- Alta precisión de regulación.
- Haute précision de régulation.
- Highly accurate adjusting.



**Empotrables a tubo · Encastrer a tube ·
Built-in tube mounted**

Standard

Ø cm	Ø cm	cm ²	ALU	Blanco Blanc White
11	8	26	040396	040389
12,5	10	40	040419	040402
15	12	56	040433	040426



Regulable · Réglable · Adjustable

Ø cm	Ø cm	cm ²	Cromo Chrome Chrome	Oro Or Gold
12	10	0 - 18	041638	040440
14	12	0 - 31	041645	040457



Malla Mosquitera · Moustiquaire · Anti-insect net

Dim.	
50 x 100 cm	014489
100 x 100 cm	014496
160 cm x 30 m	014502



- Malla mosquitera de fibra de vidrio. Presentación en rollo.
- Moustiquaire fiberglass. En rouleau.
- Mesh fiberglass insect screen. Presentation roll.



Rejillas de Aluminio
Grilles en Alu
Aluminium Grilles

000000 Ref.
Codigo EAN = 8421272 + Ref.



Reforzadas con borde · Renforcées avec cadre · Reinforced with edging

SERIE 10

		1,5	1,5
A x B	cm ²	ALU	Bianco Blanc White
10 x 10	17	007108	007207
10 x 20	34	007115	007214
10 x 30	51	007122	007221
10 x 39	68	007139	007238
10 x 49	85	007146	007245
10 x 60	103	007153	007252
10 x 80	137	007160	007269
10 x 99	171	007177	007276



SERIE 20

		1,5	1,5
A x B	cm ²	ALU	Bianco Blanc White
20 x 10	36	007900	008006
20 x 20	72	007917	008013
20 x 30	108	007924	008020
20 x 39	144	007931	008037
20 x 49	180	007948	008044
20 x 60	217	007955	008051
20 x 80	289	007962	008068
20 x 99	361	007979	008075



SERIE 30

		1,5	1,5
A x B	cm ²	ALU	Bianco Blanc White
30 x 10	55	007702	007801
30 x 20	110	007719	007818
30 x 30	165	007726	007825
30 x 39	220	007733	007832
30 x 49	275	007740	007849
30 x 60	331	007757	007856
30 x 80	441	007764	007863
30 x 99	551	007771	007870



SERIE 39

		1,5	1,5
A x B	cm ²	ALU	Bianco Blanc White
39 x 10	114	007504	007603
39 x 20	152	007511	007610
39 x 30	228	007528	007627
39 x 39	304	007535	007634
39 x 49	380	007542	007641
39 x 60	456	007559	007658
39 x 80	608	007566	007665
39 x 99	760	007573	007672



SERIE 49

		1,5	1,5
A x B	cm ²	ALU	Bianco Blanc White
49 x 10	97	007009	007405
49 x 20	194	007016	007412
49 x 30	291	007023	007429
49 x 39	388	007030	007436
49 x 49	484	007047	007443
49 x 60	581	007054	007450
49 x 80	775	007061	007467
49 x 99	969	007078	007474



- Fabricación sobre pedido. Consultar plazo de entrega. Gran capacidad de paso de aire. Especial para garajes, salas de máquinas, sótanos.
- Fabrication sur commande. Demander le délais de livraison. Grande capacité de passage d'air. Spécial pour les garages, les salles de machines, caves.
- Manufactured to order. Check delivery terms. Large capacity air flow. Purpose-built for garage, machinery rooms, basement.





Rejillas de Aluminio

Grilles en Alu

Aluminium Grilles





Reforzadas sin borde · Renforcées sans cadre · Reinforced without edging

 cm	 mm	1,5	1,5
A x B	 cm ²	ALU	Blanco Blanc White
20 x 25	108	028462	028547
30 x 25	162	028479	028554
40 x 25	243	028486	028561
50 x 25	297	028493	028578
20 x 50	216	028509	028585
30 x 50	324	028516	028592
40 x 50	487	028523	028608
50 x 50	595	028530	028615



Con Mosquitera · Avec moustiquaire · Whit net

 cm	 mm	1,5	1,5
A x B	 cm ²	ALU	Blanco Blanc White
20 x 25	108	028622	028707
30 x 25	162	028639	028714
40 x 25	243	028646	028721
50 x 25	297	028653	028738
20 x 50	216	028660	028745
30 x 50	324	028677	028752
40 x 50	487	028684	028769
50 x 50	595	028691	028776



- Gran capacidad de paso de aire. Especial para garajes, salas de máquinas, sótanos.
- Grande capacité de passage d'air. Spécial pour les garages, les salles de machines, caves.
- Check delivery terms. arge capacity air flow. Purpose-built for garage, machinery rooms, basement.

PASOS A SEGUIR · ETAPES · STEP BY STEP GUIDE

1.- Tomar medidas (alto x ancho) del hueco a cubrir

Mesurer l'espace a couvrir (Hauteur x Largeur)

Measure the space to be covered (height x width)



SOBREPONER · SUPERPOSER · MOUNTED

A nivel de superficie
À niveau de surface
At surface level

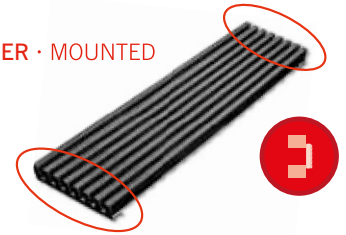

2.- Elegir el sistema de instalación:

Choisir le système d'installation:
Choose the installation system:

EMPOTRAR · À Encastrer · EMBEDDED

Integrada en el hueco
Intégré dans le trou
Integrated within the gap

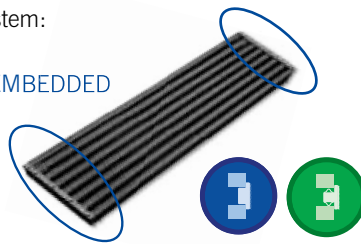

MARCO · CADRE · FRAMED

A nivel de superficie, o para encastrar en forma cuadrada o rectangular.
À niveau de surface en forme carrée ou rectangulaire.
Flush with the surface either square or rectangular.

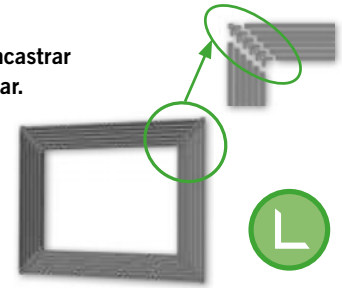

2 Terminales de sobreponer · 2 Bornes à surface · 2 Mounted terminals

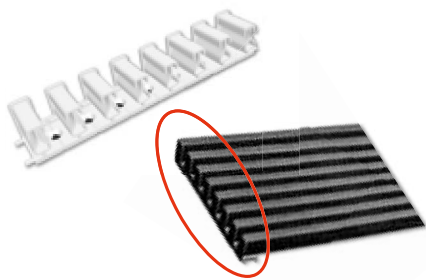

		Blanco Blanc White	Gris Gris Grey
8	11,8 x 2,05 x 1,9	046688	046619
24	36,8 x 2,05 x 1,9	046701	046633



2 Terminales de empotrar · 2 Bornes à encastrer · 2 Embedded terminals

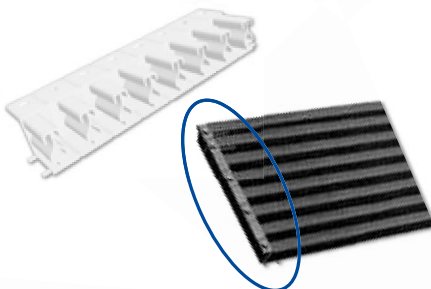

		Blanco Blanc White	Gris Gris Grey
3	3,1 x 3,6 x 1,9	046671	046602
8	11,8 x 3,6 x 1,9	046695	046626
24	36,8 x 3,6 x 1,9	046718	046640



4 Terminales para marco · 4 Bornes à encadrer · 4 Framed terminals



		Blanco Blanc White	Gris Gris Grey
6	11,8 x 4 x 1,9	046732	046664



Conector lamas · Connecteur lamelles · Slat connector

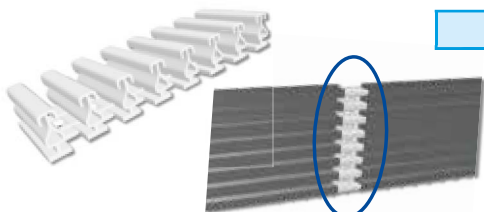

		Gris Gris Grey
8	11,8 x 4 x 1,9	046657



LUXAIR EVO

BY FEPRÉ

3.- Elegir la altura de la rejilla mediante los componentes de la instalación:
Choisir l'hauteur de la grille travers les composants du système:
Choose the height's grille according to the installation components:

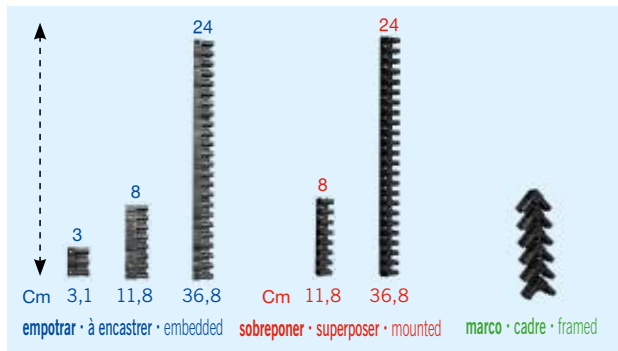

Los terminales se ajustan mediante corte por cutter
Les bornes s'adaptent avec coupe de cutter
The ends can be adjusted by cutting them with a box cutter



4.- Elegir la longitud y el color de la rejilla:
Choisir la longueur et couleur de la grille:
Choose your preferred length and colour for the grille:

- 30 ó 60 cm en blanco, alu, inox o negro
- 30 ó 60 cm en blanc, alu, inox ou noir.
- 30 or 60 in. in white, alum., stainless steel or black.

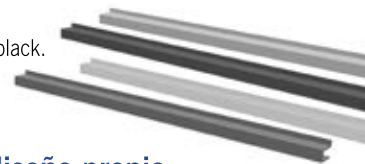

Fácil, rápido, económico y con diseño propio
Facile, rapide, économique et avec design propre
Easy, quick, affordable and with your own design

Mira el video.
Voir le vidéo.
Ver o vídeo.
Watch the video.

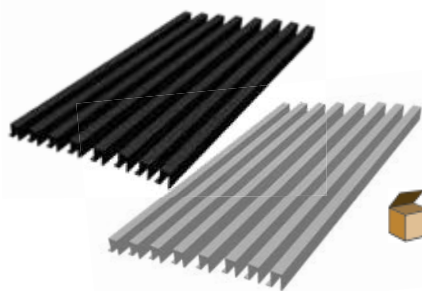
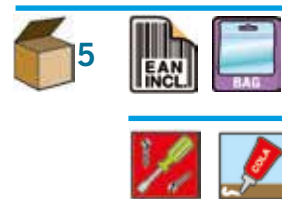

Pack 8 Lamas · Pack 8 Lamelles · Pack 8 Sheets

mm	cm	Blanco Blanc White	Plata mate Argent mat Matt Silver	Negro Noire Black	Inox.
0,5	30 x 1,5 x 1,5 und.	046794	046817	046800	046824
0,5	60 x 1,5 x 1,5 und.	046756	046770	046763	046787



Kit para encastrar · Kit à encastrer · Kit to embedded

mm	cm	Blanco Blanc White	Plata mate Argent mat Matt Silver	Negro Noire Black	Inox.
3	60 x 3,1 x 1,9	046831	046855	046848	
8	60 x 11,8 x 1,9	047869			047876



2 terminales de empotrar y 8 lamas de 60 cm.
2 bornes à encastrer et 8 lamelles de 60 cm.
2 terminals to embedded and 8 sheets of 60 cm.

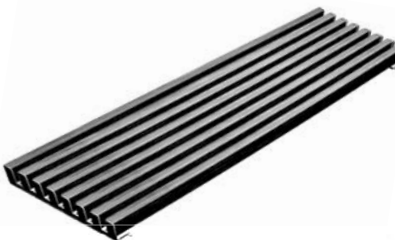

Kit para horno · Kit Four · Oven Kit

mm	cm	Blanco Blanc White	Plata mate Argent mat Matt Silver	Negro Noire Black	Inox.
5	60 x 11,8 x 1,9	046862	046886	046879	046893



2 terminales de sobreponer y 8 lamas de 60 cm.
2 bornes à surface et 8 lamelles de 60 cm.
2 terminals to mounted and 8 sheets of 60 cm.



Cortador de lamas · Coupe-lames · Cutter sheets



CÁLCULO DEL PASO DE AIRE

Con esta sencilla fórmula puede calcular el paso de aire de la rejilla:
Anchura en cm rejilla x 0.2* x (número de láminas - 1) = cm² Paso de Aire

ejemplo:
60 cm
60 x 0.2 x 4 = 48 cm² Paso Aire

*espacio entre láminas

CALCUL DU DÉBIT D'AIR

À l'aide d'une simple formule permet de calculer le débit d'air de la grille:
Largeur en cm de grille x 0.2* x (nombre de lames - 1) = cm² Débit d'Air

exemple:
60 cm
60 x 0.2 x 4 = 48 cm² Débit d'Air

*Écart entre lamelles

CALCULATING THE AIR PASSAGE

Using a simple formula can calculate the airflow grille as you designed:
Width in cm of the grating x 0.2* x (number of blades - 1) = cm² Air Pass

example:
60 cm
60 x 0.2 x 4 = 48 cm² Air Pass

*gap between slats

Rejillas con Copa
Grilles avec dôme
Grilles with dome

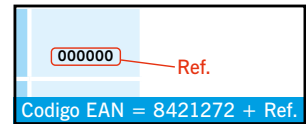

Bocas y difusores decorativos para puntos de suministro o sistemas de ventilación de escape en edificios particulares, públicos o industriales.

Bouches et diffuseurs décoratifs pour points d'alimentation ou systèmes de ventilation par extraction dans les bâtiments privés, publics ou industriels.

Decorative nozzles and diffusers for supply points or exhaust ventilation systems in private, public or industrial buildings.

Para atornillar · À visser · To be screwed in

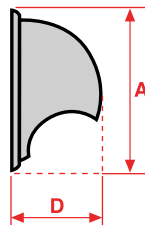

A	D	Ø ext. mm	cm ²	Inox.
183	95	183	47	024242
215	106	215	71	024259



- Alta calidad de fabricación. SUS 304. Acabado inox natural barnizado.
- Fabrication de haute qualité: SUS 304. Finition inox naturel vernie.
- High manufacturing quality: SUS 304. Lacquered natural stainless steel finish.

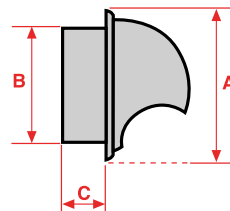

Empotrables · À encastrer · Built-in

A	B	C	Ø tub. mm	cm ²	Inox.
133	97	52	100	48	024020
165	120	52	125	82	024037
192	150	62	150	126	024044



- Alta calidad de fabricación. SUS 304. Acabado inox natural barnizado.
- Fabrication de haute qualité: SUS 304. Finition inox naturel vernie.
- High manufacturing quality: SUS 304. Lacquered natural stainless steel finish.

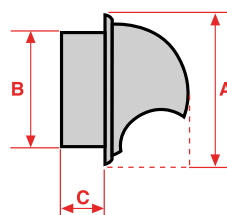

A	B	C	Ø tub. mm	cm ²	Blanco Blanc White
149	98	51	97 - 111	24	024181
181	107	55	120 - 138	36	024198



Difusores
Diffuseurs
Diffusers

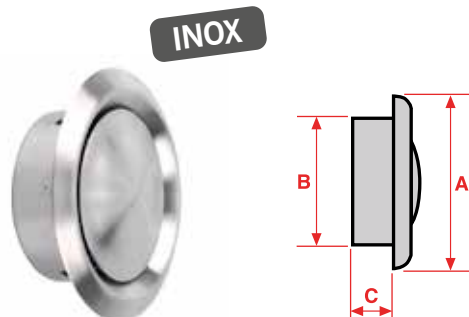

Para empotrar. Regulables
À encastrer. Réglables
Built-in. Adjustable

INOX

A	B	C	 cm ²	Inox.
138	97	45	0-32	024204
178	120	45	0-57	024211



- Alta calidad de fabricación. SUS 304. Acabado inox natural barnizado. **CON REGULACIÓN DEL CAUDAL DE AIRE.**
- Fabrication de haute qualité: SUS 304. Finition inox naturel vernie. **CONTRÔLE D'AIR.**
- High manufacturing quality: SUS 304. Lacquered natural stainless steel finish. **WITH ADJUSTABLE AIR FLOW.**



ACERO



A	B	C	 cm ²	Blanco Blanc White
138	97	45	0-32	024228
170	120	45	0-57	024235



- **CON REGULACIÓN DEL CAUDAL DE AIRE.**
- **CONTRÔLE D'AIR.**
- **WITH ADJUSTABLE AIR FLOW**



ABS



 Ø cm	 Ø cm	 cm ²	Blanco Blanc White
13,8	10	0 - 60	041492
14,5	12	0 - 60	041508



- **CON REGULACIÓN DEL CAUDAL DE AIRE.**
- **CONTRÔLE D'AIR.**
- **WITH ADJUSTABLE AIR FLOW**



ABS

 A x B	 Ø cm	 cm ²	Blanco Blanc White
16 x 15,5	12,5	30 - 90	041652



Entradas de aire para puertas y ventanas
Entrées d'air pour portes et fenêtres
Air inlets for windows and doors



Video de instalación
Vidéo d'installation
Vidéo de montage
Assembly video

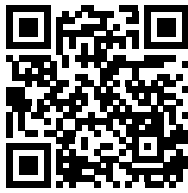

000000 Ref.
Codigo EAN = 8421272 + Ref.

ABS

Caudal regulable · Débit réglable · Adjustable flow

			Blanco Blanc White	Marrón Marron Brown
A x B x C	A x B	m ³ /h	041195	041201
2,3 x 29,5 x 2	1,5 x 23,5	15 - 22 - 30		

Caudal regulable y reducción acústica
Débit réglable et réduction acoustique
Adjustable flow and acoustic reduction

			Blanco Blanc White	Marrón Marron Brown
A x B x C	A x B	m ³ /h	041218	041225
4,5 x 40,2 x 3,7	1,6 x 29,5	15 - 22 - 30		

Alu anodizado · Alu anodisé · Anodized Alu

		Plata mate Argent mat Matt Silver
A x B	m ³ /h	041232
2,1 x 28,5	20	

		Plata mate Argent mat Matt Silver
A x B	m ³ /h	041249
2,8 x 29,7	26	

Regulable · Réglable · Adjustable

		Plata mate Argent mat Matt Silver
A x B	m ³ /h	041256
2,2 x 27,5	0 - 15	









Rejillas de ABS

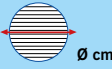





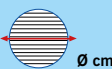

Grilles en ABS

ABS Grilles









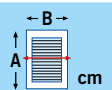

Para atornillar · À visser · To be screwed in

	Ø cm		cm ²	Blanco Blanc White	 5  
6,4		5,7		040921	  

	Ø cm		cm ²	Blanco Blanc White	 5  
10,3		17,4		040938	  









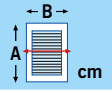

Extraplana · Extra-plate · Extra slim

	A x B cm		cm ²	Blanco Blanc White	 5  
11 x 25,5		101		040617	  
13,1 x 33,7		188		040754	









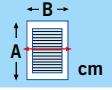

Con remarco · Double cadre · With remarked

	A x B cm		cm ²	Blanco Blanc White	 5  
9 x 26		52		040631	  
16,5 x 26		130		040716	
24 x 26		200		040891	



Anti lluvia · Anti-pluie · Rain-proof

	A x B cm		cm ²	Blanco Blanc White	Beige	 5  
14,6 x 17,5		88		041188	040662	  

Rejillas de ABS
Grilles en ABS
ABS Grilles

000000 Ref.
Codigo EAN = 8421272 + Ref.



Para atornillar · À visser · To screw

		Blanco Blanc White
A x B	cm ²	
8,6 x 16,5	35	040570



Regulables · Réglable · Adjustable

Regulable anti lluvia · Réglable anti-pluie · Adjustable rain-proof

		Blanco Blanc White
A x B	cm ²	
14,6 x 17,5	0 - 88	040648



Regulable con cordel · Réglable avec cordelette · Adjustable with pull cord

		Blanco Blanc White
A x B	cm ²	
17 x 16	0 - 88	040860



Regulable plana · Régable plate · Adjustable slim

		Blanco Blanc White
A x B	cm ²	
9,1 x 19,3	0 - 10	040587
10,7 x 28,4	0 - 23	040624
19,3 x 28,9	0 - 48	040709





Rejillas de ABS

Grilles en ABS

ABS Grilles





Empotrables · Encastrer · Built-in

 Ø cm	 Ø cm	 cm ²	Blanco Blanc White
4	3,2	6,5	040914





Estándar · Standard · Standard

 Ø cm	 Ø cm	 cm ²	Blanco Blanc White	Beige
9,8	7,6	11	040945	
12	9,4	26	040952	041065
15	11,8	30	040969	041171
19	15,2	53	041034	





Regulable · Réglable · Adjustable

 Ø cm	 Ø cm	 cm ²	Blanco Blanc White
9,8	7,6	0 - 11	041096
12	9,4	0 - 26	041102
15	11,8	0 - 30	041119
19	15,2	0 - 53	041126



Estándar · Standard · Standard

 cm	 cm	 cm ²	Blanco Blanc White
A x B	A x B		
14 x 14	10 x 10	42	040822





Rejillas de ABS
Grilles en ABS
ABS Grilles

000000 Ref.
Codigo EAN = 8421272 + Ref.



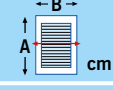
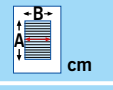

Empotrables · Encastrer · Built-in

Con Patillas de Encastre · Avec pattes d'encastrement · Whit lock-in pins

 cm	 cm	 cm ²	Blanco Blanc White
A x B	A x B		
12 x 12	10 x 10	50	040815



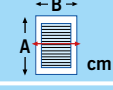
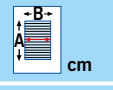

Regulable · Réglable · Adjustable

 cm	 cm	 cm ²	Blanco Blanc White
A x B	A x B		
14 x 14	10 x 10	0 - 30	040839



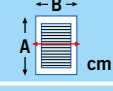
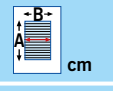





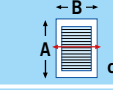

Estándar · Standard · Standard

 cm	 cm	 cm ²	Blanco Blanc White
A x B	A x B		
10,7 x 25,7	8,5 x 23	91	040600
13 x 37	9,5 x 33,3	155	040761
23 x 38	18,6 x 33,4	198	040785



Premontada con marco · Pré-assemblé avec cadre · pre-assembled with frame

 cm	 cm ²	Grís Gris Gray	
A x B			
20 x 20	66	082150	
20 x 30	68	082167	
20 x 20	0 - 26	082174	 
20 x 30	0 - 30	082181	 





Rejillas de ABS
Grilles en ABS
ABS Grilles

Empotrables · Encastrer · Built-in

Opción atornillar · Option visser · Screw-in option





 cm	 cm	 cm ²	Blanco Blanc White
A x B	A x B		
8 x 16,4	6,1 x 13	41	040563
10,2 x 22,1	7,8 x 17,9	83	040594
12,9 x 25,1	10,7 x 21	138	040686
15,2 x 27,6	13 x 23,6	185	040723



Estrechas · Etroites · Slim





 cm	 cm	 cm ²	Blanco Blanc White
A x B	A x B		
6 x 30,5	4 x 28,3	40	040730
6 x 51,5	4 x 49,7	69	040808



Doble cara puertas · Double face spécial portes · Double-sided to door





 cm	 cm	 cm ²	Blanco Blanc White
A x B	A x B		
9 x 45	7,6 x 43	187	4,701 040792



- Tornillos incluidos.
- Visserie fournie.
- Screws included.

Multirregulable · Multi-réglable · Multi-adjustable



 cm	 cm	 cm ²	Blanco Blanc White
A x B	A x B		
14,6 x 25	11,9 x 22,4	0 - 67	040693





Rejillas de ABS
Grilles en ABS
ABS Grilles

000000 Ref.
Codigo EAN = 8421272 + Ref.





Empotrables · Encastrer · Built-in

Schun

 cm	 cm	 cm ²	Blanco Blanc White
A x B	A x B		
26 x 13,3	22 x 9,5	69	020107





Schun regulable · Réglable · Adjustable

 cm	 cm	 cm ²	Blanco Blanc White
A x B	A x B		
26 x 13,3	22 x 9,5	0-69	020121





Kit rejilla + Tubo telescópico + Válvula antirretorno
Kit traverse mural avec grille, tube et clapet anti retour
Grille kit + telescopic duct + non-return valve

 cm	 cm	 cm ²	Long. Tubo cms	Blanco Blanc White
A x B				
15 x 15	10	47	18 - 35	041461



Kit rejilla + Tubo con aletas de encastre
Bouche d'extraction VMC
Grille kit + duct with locking-in flaps

 cm	 cm	 cm ²	Blanco Blanc White
A x B			
10,5 x 12,6	8	30	041478
16 x 19	12	85	041485



Rejillas de ABS



Grilles en ABS

ABS Grilles

Empotrable a tubo · Encastrer a tube · For built-in tube mounting

Salida Multiformas · Sortie Multiformes · Multiform output

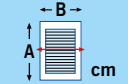
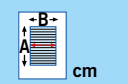
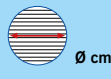



 cm	 cm	 Ø cm	 cm ²	Blanco Blanc White
A x B	A x B			
14,5 x 14	5,5 x 11	10	0 - 67	028844
15 x 15	5,5 x 11	10 - 12	0 - 47	041423
16,5 x 18,5	7,5 x 15	-	0 - 97	028851
16,5 x 18,5	-	12	0 - 102	028837
18,5 x 18,5	-	15	0 - 115	041669



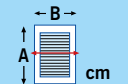
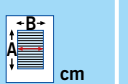
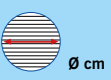

- Permiten la salida de aire pero no su entrada
- Permet la sortie d'air, mais non son entrée.
- Air can go out but not in.



 cm	 cm	 Ø cm	 cm ²	Blanco Blanc White
A x B	A x B			
15 x 15	5,5 x 11	10 - 12	47	041416

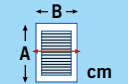
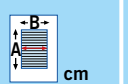
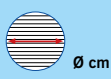



 cm	 cm	 Ø cm	 cm ²	Blanco Blanc White
A x B	A x B			
15 x 15	5,5 x 11	10 - 12	0 - 47	041430



Multidiámetro. Lamas Móviles · Multi diamètre. Volets mobiles
· Multidiameter. Movable planks.

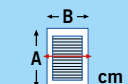
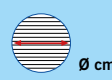

 cm	 Ø cm	 cm ²	Blanco Blanc White	Beige
A x B				
16 x 15,5	10 - 13	71	041447	041454









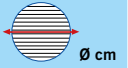
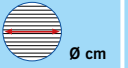

Rejillas de ABS
Grilles en ABS
ABS Grilles

000000 Ref.
Codigo EAN = 8421272 + Ref.





Empotrable a tubo · Encastrer a tube · For built-in tube mounting

Con clips · Avec clips · With lock clips

 Ø cm	 Ø cm	 cm ²	Blanco Blanc White	Beige	 5     
10	8 - 9	19	040990	041041	
12,1	10 - 11	30	041003	041058	
14,7	12,5 - 14	47	041010	041072	
18,2	16 - 17	81	041027	041089	



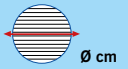
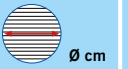



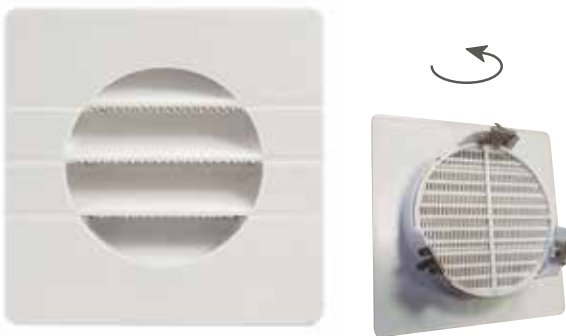

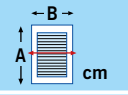
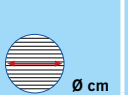

Redondas (GAT) · Rondes (GAT) · Circulares (GAT)

 Ø cm	 Ø cm	 cm ²	Blanco Blanc White	 5    
10,5	8 - 9	25	032001	
12,5	10	42	032018	
13,2	11	53	032025	
14,4	12 - 12,5	70	032032	
16	14	93	032049	
18	16	124	032056	



Cuadradas (GETM) · Carrées (GETM) · Square (GETM)

 A x B cm	 Ø cm	 cm ²	Blanco Blanc White	 5     
11 x 11	8 - 9	8,5	032063	
12,5 x 12,5	10	14	032070	
14 x 14	11 - 12	18,3	032087	
15 x 15	12,5	25	032094	
16,5 x 16,5	14	32	032100	
18,4 x 18,4	16	43	032117	



Cuadradas (GETM+) · Carrées (GETM+) · Square (GETM+)

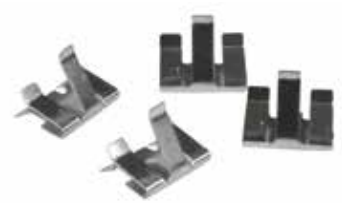
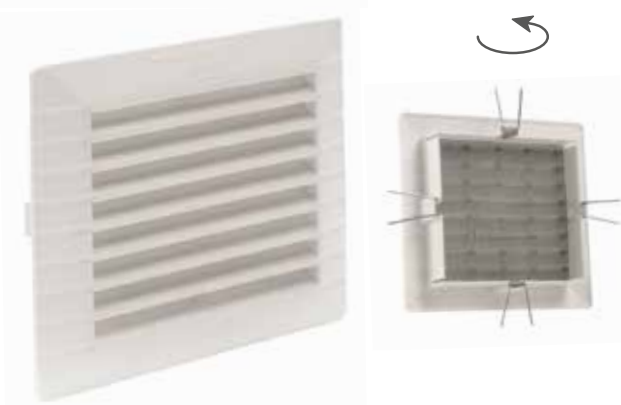

 A x B cm	 Ø cm	 cm ²	Blanco Blanc White	 5     
12,5 x 12,5	10	14	046558	
13,8 x 13,8	11	18	046565	
14,8 x 14,8	12	25	046572	

Rejillas de ABS
Grilles en ABS
ABS Grilles





Empotrable a tubo · Encastrer a tube · For built-in tube mounting

Estándar · Standard · Standard

 Ø cm	 Ø cm	 cm ²	Blanco Blanc White	Beige
13,5	8 - 12,5	44	040976	041157
17,5	12,5- 16	66	040983	041164
23,5	16,5- 22	202	041140	041133





Anti lluvia · Anti-pluie · Rain-proof

 cm	 cm	 cm ²	Blanco Blanc White
15,5 x 18,3	9 - 16	88	040655





Estándar · Standard · Standard

 cm	 cm	 cm ²	Blanco Blanc White
A x B	A x B		
13,5 x 13,5	11 x 11	54	040853
18,2 x 18,2	15,9 x 15,9	105	040877
23 x 23	20,6 x 20,6	203	040884
13,5 x 30,4	11 x 27,2	136	040747
23 x 13,5	20,7 x 11	105	040679



Regulable · Réglable · Adjustable

 cm	 cm	 cm ²	Blanco Blanc White
A x B	A x B		
13,5 x 13,5	11 x 11	0 - 54	040846
23 x 13,5	20,7 x 11	0 - 105	040907



Kit 4 patillas metálicas



Aeroventiladores de función mecánica
Aérateurs a lamelles
 Mechanical air ventilators



Spécial GAZ
 Especial GAS
 Special GAS

2 POSIBILIDADES DE INSTALACIÓN

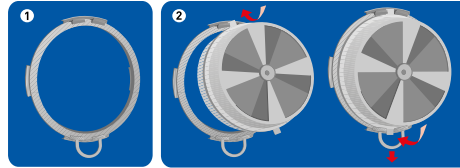

empotrar con pre-marco

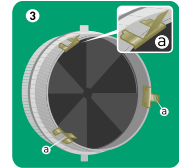

empotrar clips





Regulable. Poliestireno transparente
 Réglable. Polystyrène transparent
 Adjustable. Transparent polystyrene

 Ø cm	 Ø cm	 cm ²	Trans.
16,7	15,7	0 - 107	041294



Especial GAS. Poliestireno transparente
 Spécial GAZ. Polystyrène transparent
 Special GAS. Transparent polystyrene

 Ø cm	 Ø cm	 cm ²	Trans.
16,7	15,7	142	041324
21	19,3	207	041331



Tapas de registro · Trappes de visite · Revision hatch door



PVC

NEW

ACERO
 ACIER
 STEEL

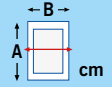

PVC

 cm	Blanco Blanc White	Plata mate Argent mat Matt Silver
A x B		
15 x 15	082198	082259
20 x 20	082204	082266
20 x 25	082211	
20 x 40	082228	082273
30 x 30	082235	
30 x 40	082242	

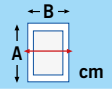

Acero · Acier · Steel

 cm	Blanco Blanc White
A x B	
15 x 15	082280
20 x 20	082297
20 x 25	082303
20 x 30	082310



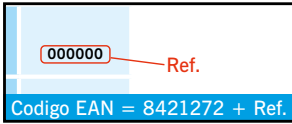

Compuerta para pequeños animales
Portes pour petits animaux
Gate for small domestic animals



Empotrable. 2 posiciones apertura
À encastrer. Ouverture en 2 positions
Built-in. 2 opening positions

		Blanco Blanc White	Marrón Marron Brown
A x B 23,5 x 21,7	A x B 18,5 x 15,8		



- Gatera empotrable en puertas de madera, metal o paredes.
- 2 posiciones de apertura.
- Atención! NO RECOMENDADA PARA CRISTAL
- Medida total 235 x 217. Medida del hueco 185 x 158. Medida máxima al suelo 147 mm.
- Châtière a encastrer sur les portes en bois, en métal ou des murs.
- Ouverture en 2 positions.
- Attention, pas recommandée sur le verre.
- Dim. total 235x217. Dim. découpé. 185 x 158. Hauteur maximal au sol 147 mm.
- Built-in cat flap for wooden, metal doors or walls.
- 2 opening positions.
- Caution! NOT RECOMMENDED FOR GLASS
- Full size 235 x 217. Hole size 185 x 158. Maximum measurement from floor 147mm.



2 posiciones de apertura
2 positions d'ouverture
2 open positions

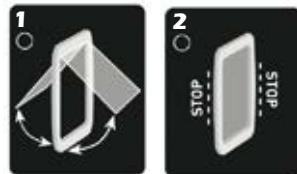

- Tornillos y plantilla incluidos
- Vis et pochoir incluses
- Parafusos e modelo incluidos
- Screws and stencil included

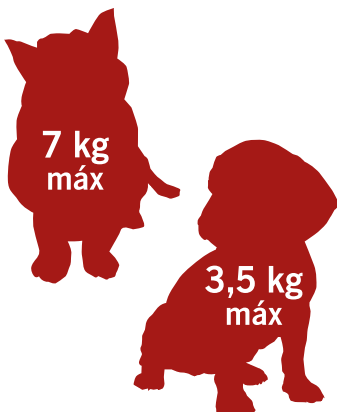

1 **2** **3** **4** **5**

6 **7** **A+B+C+D**
*TUNNEL EN OPTION
TUNEL OPTIONAL
OPTIONAL TUNNEL

* Pour portes standard de 38 mm. Para puertas estándar de 38 mm. Para portas padrão de 38 mm. For standard 38 mm doors.

8 **9**

Épaisseur porte	45 mm	1
Grosor puerta	40 mm	2
Espeçura porta	35 mm	3
Door thickness	30 mm	4

Compuerta
Carter
Cat
Cats



EXTRACTORES Y ACCESORIOS DE AIREACIÓN
EXTRACTEURS ET ACCESSOIRES AÉRATION
EXTRACTORS AND VENTILATION ACCESSORIES



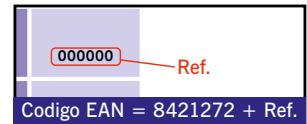

NEW

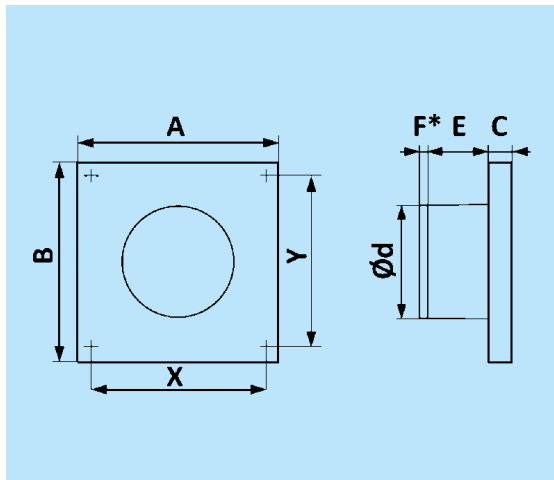

COLOCACIÓN PLACEMENT SETTING

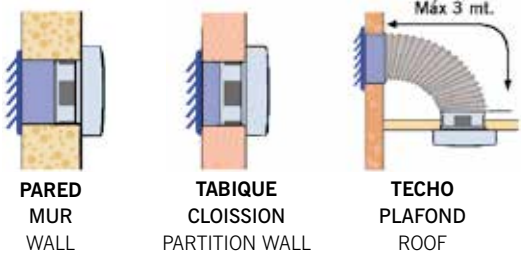

IP 24

OPTIMA

- Extractor axial para ventilación continua o periódica de baños, cocinas y otros espacios públicos.
- Bajo nivel sonoro.
- Capacidad de extracción máxima de 183 m³/h.
- Extracteur axial pour la ventilation régulière ou continue de salles de bains, cuisines et autres espaces publics.
- Faible niveau de bruit.
- Capacité d'extraction maximale de 183 m³/h.
- Axial extractor for continuous or periodic ventilation of bathrooms, kitchens and other public areas.
- Low noise level.
- Maximum extraction capacity 183 m³/h.

DIMENSIONES · DIMENSIONS · SIZING

mm	d	A	B	X	Y	E	F*	C
OPTIMA 4	100	150	150	135	135	55	8	22
OPTIMA 5	125	175	175	160	160	61	10	23

CARACTERÍSTICAS · CARACTÉRISTIQUES · FEATURES

	OPTIMA 4	OPTIMA 5
Ø mm	100	125
(m ³ /h)	97	183
W	14	14
dB (A)	35	36
Kg	0,44	0,50

VERSIONES · VERSIONS · VERSIONS

Ø mm				
100	082037	082051	082075	082099
125	082044	082068	082082	082105





NEW

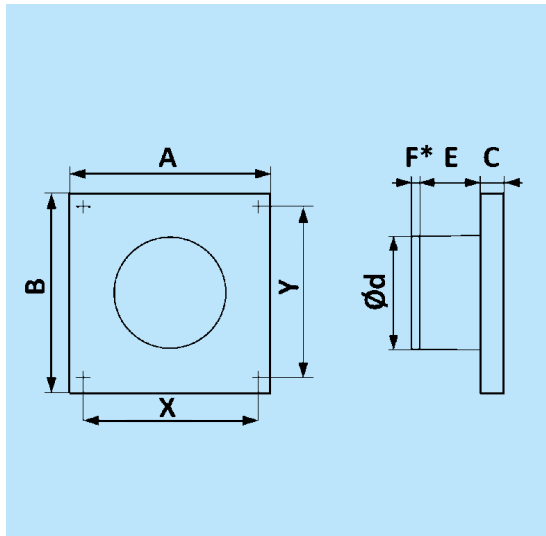

COLOCACIÓN PLACEMENT SETTING

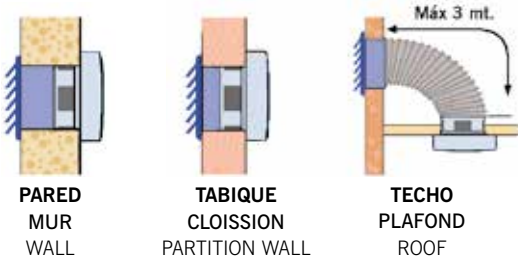

PARED
MUR
WALL

TABIQUE
CLOISSON
PARTITION WALL

TECHO
PLAFOND
ROOF



SLIM

- Extractor axial para ventilación continua o periódica de baños, cocinas y otros espacios públicos.
 - Motor de rodamiento de bolas. Vida útil prolongada (hasta 40.000 horas de funcionamiento) y un bajo consumo de energía.
 - Bajo nivel sonoro.
 - Capacidad de extracción máxima de 250 m³/h.
- Extracteur axial pour la ventilation régulière ou continue de salles de bains, cuisines et autres espaces publics.
 - Moteur à roulement à billes. Longue durée de vie (jusqu'à 40 000 heures de fonctionnement) et faible consommation d'énergie.
 - Faible niveau de bruit.
 - Capacité d'extraction maximale de 250 m³/h.
- Axial extractor for continuous or periodic ventilation of bathrooms, kitchens and other public areas.
 - Ball bearing motor. Long service life (up to 40,000 hours of operation) and low power consumption.
 - Low noise level.
 - Maximum extraction capacity 250 m³/h.

DIMENSIONES · DIMENSIONS · SIZING

mm	d	A	B	X	Y	E	F*	C
SLIM 4	100	160	160	140	140	76	7	9
SLIM 5	125	180	180	160	160	82	8,5	9
SLIM 6	150	205	205	187	187	86	10	9

CARACTERÍSTICAS · CARACTÉRISTIQUES · FEATURES

	SLIM 4	SLIM 5	SLIM 6
Ø mm	100	125	150
(m³/h)	90	140	250
W	7,8	10	10
dB (A)	25	30	33
Kg	0,50	0,60	0,72

VERSIONES · VERSIONS · VERSIONS

Ø mm				
100	081887	081894	081931	081955
125	081900	081917	081948	081962
150	081924	081924		



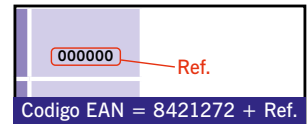

NEW

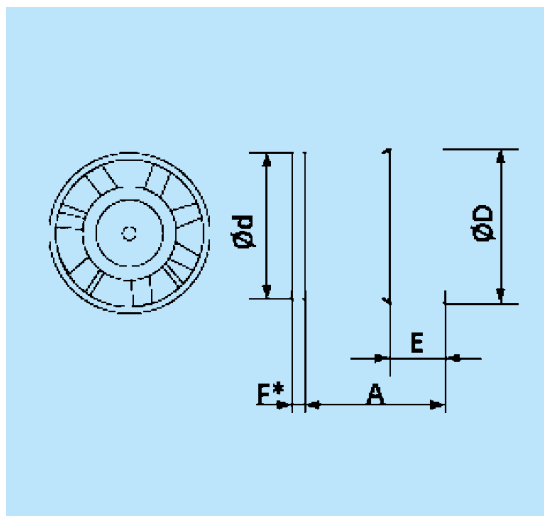

COLOCACIÓN PLACEMENT SETTING

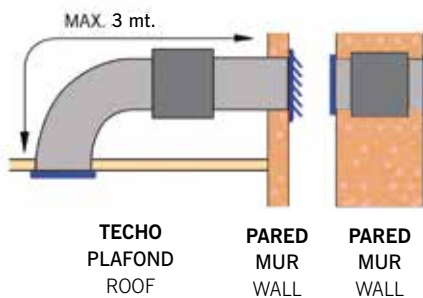

IP 24

CONDUCT

- Extractor tubular en línea para conductos rígidos o flexibles.
- Capacidad de extracción máxima de 280 m³/h.
- Motor de bajo voltaje
- Diseñado para funcionamiento continuo.
- Extracteur tubulaire en ligne pour tubes et gaines rigides ou flexibles.
- Capacité d'extraction maximale de 280 m³/h.
- Moteur basse tension.
- Conception pour un fonctionnement continu.
- In-line tubular extractor for rigid or flexible ducts.
- Maximum extraction capacity 280 m³/h
- Low voltage engine.
- Designed for continuous operating.

DIMENSIONES · DIMENSIONS · SIZING

mm	d	D	A	E	F*
VP 4	100	103	80	30	8
VP 5	125	128	82	30	10
VP 150	150	153	104	35	10

CARACTERÍSTICAS · CARACTÉRISTIQUES · FEATURES

	VP 4	VP 5	VP 6
Ø mm	100	125	150
(m ³ /h)	107	190	280
W	14	18	22
dB (A)	35	36	37
Kg	0,31	0,41	0,60

VERSIONES · VERSIONS · VERSIONS

Ø mm	
100	082006
125	082013
150	082020



NOVEDAD EN ESTE CATÁLOGO · NOUVEAU DANS CE CATALOGUE · NEW IN THIS CATALOG

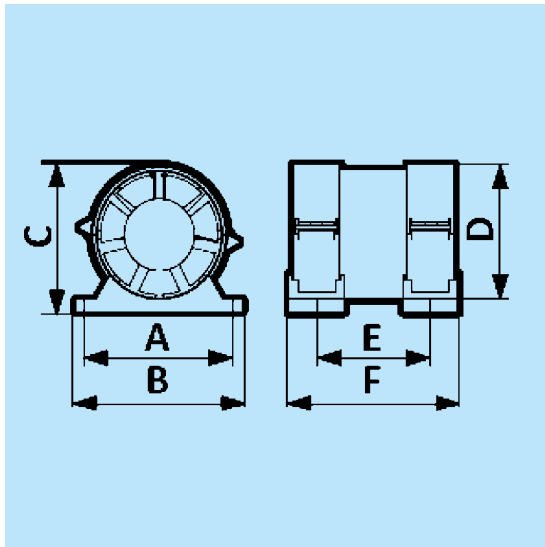

COLOCACIÓN PLACEMENT SETTING

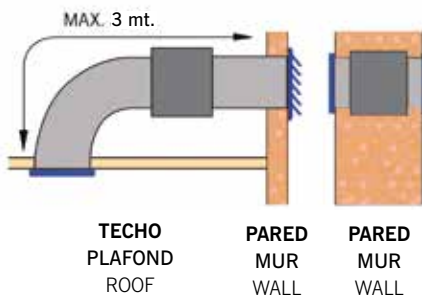

IP 24

CONDUCT PLUS

- Extractor tubular en línea para conductos rígidos o flexibles para ventilación continua o periódica de baños, cocinas y otros espacios públicos.
- Capacidad de extracción máxima de 320 m³/h.
- Motor de bajo voltaje
- Diseñado para funcionamiento continuo.
- Extracteur tubulaire en ligne pour tubes et gaines rigides ou flexibles pour la ventilation régulière ou continue de salles de bains, cuisines et autres espaces publics.
- Capacité d'extraction maximale de 320 m³/h.
- Moteur basse tension.
- Conception pour un fonctionnement continu.
- In-line tubular extractor for rigid or flexible ducts for continuous or periodic ventilation of bathrooms, kitchens and other public areas with sound limitations
- Maximum extraction capacity 320 m³/h
- Low voltage engine.
- Designed for continuous operating.

DIMENSIONES • DIMENSIONS • SIZING

mm	A	B	C	D	E	F
PRO 4	122	138	119	103,6	94	139
PRO 5	147	163	144	128,6	101	146
PRO 6	182	198	179	163,5	104	154

CARACTERÍSTICAS • CARACTÉRISTIQUES • FEATURES

	PRO 4	PRO 5	PRO 6
Ø mm	100	125	160
(m ³ /h)	115	195	320
W	14	18	22
dB (A)	32	34	36
Kg	0,51	0,55	0,87

VERSIONES • VERSIONS • VERSIONS

Ø mm	
100	081979
125	081986
150	081993



Accesorios para extractores
Accessoires extraction
Accessories for extractors

000000 Ref.
Codigo EAN = 8421272 + Ref.







Válvula antiretorno · Clapet anti-retour · Check valve

La válvula anti-retorno está diseñada para extractores axiales domésticos y es un dispositivo de protección contra la corriente de aire desde el conducto de ventilación hasta el interior de la vivienda. Proporciona protección contra todo tipo de olores que pueden filtrarse por los agujeros de ventilación. Solapas resistentes al desgaste. Facilidad de instalación.

Le clapet anti-retour est conçu pour les ventilateurs axiaux domestiques et est un dispositif de protection contre les courants d'air du conduit de ventilation vers l'appartement. Fournit une protection contre toutes sortes d'odeurs qui peuvent s'infiltrer à travers les orifices de ventilation. Portez des volets résistants. Facilité d'installation.

The check valve is designed for domestic axial fans and it is a protection device against the draft of air from the ventilation duct to the apartment. Provides protection against all kinds of odors that can seep through the ventilation holes. Wear resistant flaps. Ease of installation.

 Ø mm		 1
Ø - 100	082112	
Ø - 125	082129	
Ø - 150	082136	



Regulador · Régulateur · Controller



Los reguladores se utilizan en sistemas de ventilación para encender / apagar y controlar la velocidad de rotación de los motores eléctricos monofásicos de los extractores. Es posible establecer la velocidad mínima del ventilador mediante una resistencia variable a la placa del controlador. El encendido, apagado y regulación de la velocidad de rotación del ventilador se realizan mediante el mando. Es posible controlar varios ventiladores si la corriente consumida total no supera el valor máximo de corriente permitido del regulador. Potencia max 2,5 A.

Les régulateurs sont utilisés dans les systèmes de ventilation pour allumer / éteindre et contrôler la vitesse de rotation des moteurs électriques monophasés dans les ventilateurs. Il est possible de régler la vitesse minimale du ventilateur à l'aide d'une résistance variable sur la carte contrôleur. L'activation, la désactivation et la régulation de la vitesse de rotation du ventilateur se réalisent au moyen de la commande. Il est possible de contrôler plusieurs ventilateurs si le courant total consommé ne dépasse pas la valeur de courant maximum autorisée du régulateur. Puissance max. 2,5 A



Regulators are used in ventilation systems to switch on / off and control the rotation speed of single-phase electric motors in fans. It is possible to set the minimum fan speed using a variable resistor on the controller board. The on, off and regulation of the speed of rotation of the fan realize by means of the control. It is possible to control several fans if the total current consumed does not exceed the maximum allowed current value of the regulator. Power max. 2,5 A.

Dim. cm		 1
8 x 8 x 6,8	082143	

Accesorios para conectividad de tubos. Acero Galvanizado
Accessoires de connectivité. Acier galvanisé.
Accessories for duct connection. Galvanised steel.



Tubo de PVC · Gaine souple de PVC · PVC duct. 60 µm



 Ø mm	 Ø cm	2,5 m	5 m
Ø - 80	Ø - 83	081283	081290
Ø - 100	Ø - 103	081306	081313
Ø - 110	Ø - 113	081320	081337
Ø - 125	Ø - 128	081344	081351
Ø - 150	Ø - 153	081368	081375



Velocidad del aire - Vitesse de l'air - Air speed : **MAX 20 m/''**
 Temperatura - Température - Temperature : **MIN/MAX -20/+70°C**
 Presión - Pression - Pressure : **Max. 1500 Pa**
 Dificil ignición - Difficile à enflammer - Difficult to ignite





Tubo flexible en alu. · Gaine souple d'alu · Flexible alu. duct 74 µm

 Ø mm	 Ø cm	2,5 m	10 m
Ø - 80	Ø - 84	081382	081399
Ø - 100	Ø - 104	081405	081412
Ø - 110	Ø - 114	081429	081436
Ø - 125	Ø - 129	081443	081450
Ø - 150	Ø - 154	081467	081474



Velocidad del aire - Vitesse de l'air - Air speed : **MAX 30 m/''**
 Temperatura - Température - Temperature : **MIN/MAX -30/+150°C**
 Presión - Pression - Pressure : **Max. 3000 Pa**
 Dificil ignición - Difficile à enflammer - Difficult to ignite

Tubo flexible semirrígido en aluminio 70 µm
Gaine de 70 µm d'aluminium semi-rigide
Flexible semi-rigid aluminium duct 70 µm

 Ø mm	 Ø cm	1,5 m	3 m
Ø - 80	Ø - 85	081481	081498
Ø - 100	Ø - 105	081504	081511
Ø - 110	Ø - 115	081528	081535
Ø - 125	Ø - 130	081542	081559
Ø - 150	Ø - 155	081566	081573



Velocidad del aire - Vitesse de l'air - Air speed : **MAX 30 m/''**
 Temperatura - Température - Temperature : **MIN/MAX -30/+250°C**
 Presión - Pression - Pressure : **Max. 3000 Pa**
No inflamable - Pas inflammable - Not flammable

Tubos y accesorios para conectividad. PVC
Tubes et accessoires de connectivité. PVC
Pipes and accessories for connectivity. PVC

De material ignífugo autoextinguible.
 Temperatura de trabajo 80°C. Ensamblaje modular.
 Matériau ignifugeant et auto-extinguible.
 Température de travail 80 °C. Assemblage modulaire.
 Of fireproof and self-extinguishing material.
 Working temperature 80°C. Modular assembly.

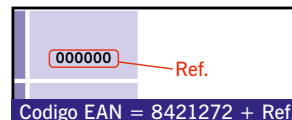

Ø 100 y 55 x 110

Ø 120 y 75 x 150

Tubo rígido · Tube rigide · Rigid duct

Dim. mm	Blanco Blanc White	Dim. mm	Blanco Blanc White
55 x 110 L = 1.000	080019	75 x 150 L = 1.000	080439
55 x 110 L = 1.500	080002	75 x 150 L = 1.500	080415



Tubo plegable · Tube pliant · Folding duct

Dim. mm	Blanco Blanc White	Dim. mm	Blanco Blanc White
55 x 110 L = 1.000	080033	75 x 150 L = 1.000	080446
55 x 110 L = 1.500	080040	75 x 150 L = 1.500	080453



Tubo rígido · Tube rigide · Rigid duct

Dim. mm	Blanco Blanc White	Dim. mm	Blanco Blanc White
Ø - 100 L = 1.000	080057	Ø - 120 L = 1.000	080460
Ø - 100 L = 1.500	080071	Ø - 120 L = 1.500	080484



Empalme · Manchon · Splice

Dim. mm	Blanco Blanc White	Dim. mm	Blanco Blanc White
55 x 110	080088	75 x 150	080491



Empalme · Manchon · Splice

Ø Dim. mm	Blanco Blanc White	Ø Dim. mm	Blanco Blanc White
Ø - 100	080095	Ø - 120	080507



Tubos y accesorios para conectividad. PVC

Tubes et accessoires de connectivité. PVC

Pipes and accessories for connectivity. PVC

Ø 100 y 55 x 110

Ø 120 y 75 x 150

Empalme mixto recto · Manchon droit mixte · Straight mixed splice



Dim. mm	Blanco Blanc White	Dim. mm	Blanco Blanc White
Ø - 100 a 55 x 110	080101	Ø - 120 a 75 x 150	080514



Codo mixto 90° · Coude mixte 90° · 90° elbow joint



Dim. mm	Blanco Blanc White	Dim. mm	Blanco Blanc White
Ø - 100 a 55 x 110	080118	Ø - 120 a 75 x 150	080521



Codo 90° · Coude 90° · 90° elbow



Dim. mm	Blanco Blanc White	Dim. mm	Blanco Blanc White
55 x 110	080125	75 x 150	080538



Codo 45° · Coude 45° · 45° elbow



Dim. mm	Blanco Blanc White
55 x 110	080132



Codo redondo flexible · Coude souple ronde · Flexible circular elbow joint



Dim. mm	Blanco Blanc White	Dim. mm	Blanco Blanc White
Ø - 100 L = 500	080149	Ø - 120 L = 500	080552



Codo rect. flexible · Coude souple rect. · Flexible rect. elbow joint



Dim. mm	Blanco Blanc White	Dim. mm	Blanco Blanc White
55 x 110 L = 500	080156	75 x 150 L = 150	080668



Tubos y accesorios para conectividad. PVC
 Tubes et accessoires de connectivité. PVC
 Pipes and accessories for connectivity. PVC

000000 Ref.
 Código EAN = 8421272 + Ref.

Ø 100 y 55 x 110

Ø 120 y 75 x 150



Codo 90° · Coude 90° · 90° elbow

Dim. mm	Blanco Blanc White	Dim. mm	Blanco Blanc White
55 x 110	080163	75 x 150	080576



Codo 90° · Coude 90° · 90° elbow

Ø Dim. mm	Blanco Blanc White	Ø Dim. mm	Blanco Blanc White
Ø - 100	080170	Ø - 120	080583



Codo 45° · Coude 45° · 45° elbow

Ø Dim. mm	Blanco Blanc White
Ø - 100	080187



Remate pared · Platine finition · Wall finish

Ø Dim. mm	Blanco Blanc White	Ø Dim. mm	Blanco Blanc White
Ø - 100	080194	Ø - 120	080613



Remate pared · Platine finition · Wall finish

Dim. mm	Blanco Blanc White	Dim. mm	Blanco Blanc White
55 x 110	080200	75 x 150	080606





Ø 100 y 55 x 110

Ø 120 y 75 x 150

Abrazadera · Fixation · Clamp

Dim. mm	Blanco Blanc White	Dim. mm	Blanco Blanc White
55 x 110	080286	75 x 150	080644



Abrazadera · Fixation · Clamp

Ø Dim mm	Blanco Blanc White	Dim. mm	Blanco Blanc White
Ø - 100	080293	Ø - 120	080651



Aro reductor · Reducteur · Ring adapter

Ø Dim. mm	Blanco Blanc White
Ø - 125 a Ø - 120	080682



Aro reductor · Reducteur · Ring adapter

Ø Dim. mm	Blanco Blanc White
Ø - 125 a Ø - 100	080309



Tubo flexible · Tube souple · Flexible duct

Dim. mm	Blanco Blanc White
Ø - 102 L = 3000	047883





SOPORTES ELECTRODOMÉSTICOS
SUPPORTS ÉLECTROMÉNAGERS
APPLIANCE BRACKETS



Soportes TV
Supports TV
TV Supports

000000 Ref.
Codigo EAN = 8421272 + Ref.



LCD-1 Fijo · Fixe · Fixed

Kg MAX. RECOM.	Kg.	Dim. TV"	VESA MAX. CM	Negro Noire Black
25	0,57	13" - 29"	10 x 10	010177



- Este soporte se presenta montado de fábrica.
- Assemblé en usine
- This support comes factory assembled



LCD-2 Giratorio e inclinable · 2 articulaciones

Orientable et basculant. 2 articulations
Turns and tilts. 2 hinges

Kg MAX. RECOM.	Kg.	Dim. TV"	VESA MAX. CM	Negro Noire Black
25	0,65	13" - 42"	20 x 20	010184



- Este soporte se presenta montado de fábrica.
- Assemblé en usine
- This support comes factory assembled



LCD-2 START Giratorio - inclinable · 1 articulación

Orientable et basculant. 1 articulation
Support. Turns. Tilts. 1 hinge

Kg MAX. RECOM.	Kg.	Dim. TV"	VESA MAX. CM	Negro Noire Black
25	0,45	13" - 29"	10 x 10	010313



- Este soporte se presenta montado de fábrica.
- Assemblé en usine
- This support comes factory assembled



LCD-3 Giratorio - inclinable · 2 articulaciones

Orientable et basculant. 2 articulations
Turns. Tilts. 2 hinges

Kg MAX. RECOM.	Kg.	Dim. TV"	VESA MAX. CM	Negro Noire Black
25	0,90	13" - 42"	20 x 20	010191





- Este soporte se presenta montado de fábrica.
- Assemblé en usine.
- This support comes factory assembled.

Soportes TV · Gama Premium
Supports TV · Gamme Premium
 TV Supports. Gamme Premium



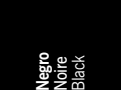

ECO-3 Giratorio e inclinable · 3 articulaciones
 Orientable et basculant. 3 articulation
 Turns and tilts. 3 hinges

 Kg MAX. RECOM.	Kg.	 Dim. TV"	 VESA MAX. CM	 Negro Noire Black
30	2.125	13" - 65"	40 x 40	010450

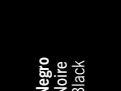

LCD-2 PREMIUM Giratorio e inclinable · 1 articulación
 Orientable et basculant. 1 articulation
 Turns and tilts. 1 hinge

 Kg MAX. RECOM.	Kg.	 Dim. TV"	 VESA MAX. CM	 Negro Noire Black
25	0,6	13" - 29"	10 x 10	040143





- Este soporte se presenta montado de fábrica.
- Assemblé en usine
- This support comes factory assembled



Cables ocultos
 Câbles cachés
 Hidden wires

LCD-3 PREMIUM Giratorio - inclinable · 2 articulaciones
 Orientable et basculant. 2 articulations
 Turns. Tilts. 2 hinges.

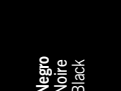

 Kg MAX. RECOM.	Kg.	 Dim. TV"	 VESA MAX. CM	 Negro Noire Black
25	0,8	13" - 29"	10 x 10	040150



- Este soporte se presenta montado de fábrica.
- Assemblé en usine
- This support comes factory assembled

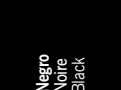

LCD-4 PREMIUM Giratorio - inclinable · 3 articulaciones
 Orientable et basculant. 3 articulaciones
 Turns-tilts. 2 hinges

 Kg MAX. RECOM.	Kg.	 Dim. TV"	 VESA MAX. CM	 Negro Noire Black
25	1	13" - 29"	10 x 10	010443



- Este soporte se presenta montado de fábrica.
- Assemblé en usine
- This support comes factory assembled

Soporte universal TV
Support universel TV
TV universal support

000000 Ref.
Codigo EAN = 8421272 + Ref.



OPERA I SLIM Fijo y ultraplano
Fixe - Ultra-plat
Fixed and ultra slim

 Kg MAX. RECOM.	Kg.	 Dim. TV"	 VESA MAX. CM	 Negro Noire Black
45	0,7	23" - 50"	20 x 40	041393



- Ultraplano, el TV queda completamente adosado a la pared. Sistema universal
- Ultra-plat. La TV reste totalement contre le mur. Système universel.
- Ultra slim. The TV is completely affixed to the wall. Universal system.



OPERA II SLIM Fijo y ultraplano
Fixe - Ultra-plat
Fixed and ultra slim

 Kg MAX. RECOM.	Kg.	 Dim. TV"	 VESA MAX. CM	 Negro Noire Black
70	1	23" - 65"	40 x 40	041409



- Ultraplano, el TV queda completamente adosado a la pared. Sistema universal
- Ultra-plat. La TV reste totalement contre le mur. Système universel.
- Ultra slim. The TV is completely affixed to the wall. Universal system.



OPERA I Inclínable · Basculant · Tilttable 15°

 Kg MAX. RECOM.	Kg.	 Dim. TV"	 VESA MAX. CM	 Negro Noire Black
45	2,1	23" - 65"	40 x 40	010214





- Este soporte se presenta montado de fábrica.
- Assemblé en usine.
- This support comes factory assembled.

Soporte universal TV
Support universel TV
TV universal support



OPERA II Inclinable · Basculant · Tilttable 15°

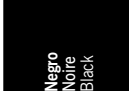



 Kg MAX. RECOM.	Kg.	 Dim. TV"	 VESA MAX. CM	 Negro Noire Black
65	2,95	23" - 84"	40 x 60	010221



- Este soporte se presenta montado de fábrica.
- Assemblé en usine.
- This support comes factory assembled.



GRAN OPERA Inclinable · Articulable · Extensible
Basculant · Articulé · Extensible
Tilttable · Adjustable · Expandable



 Kg MAX. RECOM.	Kg.	 Dim. TV"	 VESA MAX. CM	 Negro Noire Black
40	6,4	23" - 65"	40 x 40	010429



- 3 puntos de giro. Extensible de 11 a 43 cm. Inclinable 15°
- 3 points de pivotement. Extensible de 11 a 43 cm. Basculant 15°.
- 3 turning points. Can be extended from 11 to 43 cm. 3 Can be tilted 15°.

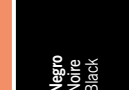

SUPREME OPERA Inclinable · Articulable · Extensible
Basculant · Articulé · Extensible
Tilttable · Adjustable · Expandable

 Kg MAX. RECOM.	Kg.	 Dim. TV"	 VESA MAX. CM	 Negro Noire Black
60	7,1	23" - 84"	40 x 60	010436



- 3 puntos de giro. Extensible de 10 a 41 cm. Inclinable 15°
- 3 points de pivotement. Extensible de 10 a 41 cm. Basculant 15°.
- 3 turning points. Can be extended from 10 to 41 cm. 3 Can be tilted 15°.

Soportes TV
Supports TV
TV supports



NEW

000000	Ref.
Codigo EAN = 8421272 + Ref.	

ECO AIR

Soporte para TV de techo
Support TV pour plafond
TV support for ceiling

 Kg MAX. RECOM.	Kg.	 Dim. TV"	 VESA MAX. CM	Negro Noire Black
30	4,34	13" - 42"	20 x 20	010467



- Extensible de 57 a 77 cm. Orientable 30°. Inclinable 10°.
- Extensible de 57 à 77 cm. Orientable 30°. Basculant 10°.
- Can be extended from 57 to 77 cm. Pivotal from 30°. Can be tilted 10°.

EPSYLON Doble giro · Double rotation · Dual turn

 cm.	 cm.	 Kg MAX. RECOM.	Kg.	 Dim. TV"	Gris Plata Gris Argenté Silver Grey
17,5+17,5	35 x 28	35	2,35	14" - 16"	010023



- Este soporte se sirve con un embellecedor de PVC para la placa de pared.
- Livré avec un enjoliveur de PVC pour le mur.
- This support can be used with a PVC trim for the wall plate.



Accesorios TV · Accessoires TV · TV accessories

VESA

Adaptador para soportes LCD Fepre
Adaptateur pour supports LCD Fepre
Adapter supports LCD Fepre

Kg.	 cm	Negro Noire Black
0,24	10 x 20, 20 x 10, 15 x 15, 20 x 20	040006



GIROPLUS 1 punto de giro · 1 point de rotation · One turning point

Ø cm	 Kg MAX. RECOM.	Kg.	 Dim. TV"	Negro Noire Black
Ø 30	40	0,4	14" - 17"	009355



- Este soporte se presenta montado de fábrica.
- Assemblé en usine.
- This support comes factory assembled.



Soportes proyector
Supports de projecteur
 Projector brackets



Soporte PROYECTOR Extensible y orientable
 Extensible et orientable
 Extendable and pivotable

 Kg MAX. RECOM.	Kg.	 Dim. TV"	Gris Plata Gris Argenté Silver Grey
20	1,7	5 - 30 cms	040198

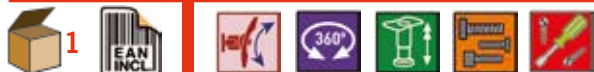

- Extensible de 5 a 30 cms. Orientable de -20° a +20°.
- Este soporte se adapta a todos los proyectores del mercado.
- Extensible de 5 a 30 cm- Orientable de -20° a +20°.
- Ce support s'adapte à tous les projecteurs du marché.
- Can be extended from 5 to 30 cms. Pivotal from -20° to +20°.
- This support can be adapted to all projectors in the market.

Soportes microondas • Supports micro-ondes • Microwave brackets



CARIBE Fijo • Fixe • Fixed

Dim. cm	 Kg MAX. RECOM.	Kg.	Blanco Blanc White	Gris Plata Gris Argenté Silver Grey
31,5	60	1,7	019330	019378



- Dos unidades por caja.
- Deux unités a la boîte.
- Two units per box.



PANAMÁ Extensible • Extensible • Extendable

Dim. cm	 Kg MAX. RECOM.	Kg.	Blanco Blanc White	Gris Plata Gris Argenté Silver Grey
29,5 - 47	60	2,15	019316	019361



- Dos unidades por caja.
- Deux unités a la boîte.
- Two units per box.

Soportes para dispositivos móviles
 Supports pour appareils mobiles
 Holders for mobile devices

000000 Ref.
 Codigo EAN = 8421272 + Ref.

Peana magnética · Socle magnétique · Magnetic pedestal



Negro
 Noire
 Black
 046589



Peana magnética · Socle magnétique · Magnetic pedestal



Negro
 Noire
 Black
 046596



Kit soporte+peana · Kit support+socle · Kit holder+pedestal



Negro
 Noire
 Black
 047005



Soportes para dispositivos móviles
Supports pour appareils mobiles
Holders for mobile devices

Soporte magnético fijo · Support magnétique fixe · Magnetic holder fixed

**MAGNET
PHONE**

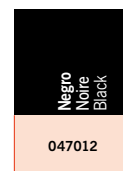

EXPOSITOR · EXPOSITEUR · DISPLAY



COMPOSICIÓN · COMPOSITION · COMPOSITION

Expositor · Expositeur · Display 8421272990202	Cant. Expos.
Soporte magnético · Support magnétique · Magnetic holder	16
Peana magnética · Socle magnétique · Magnetic pedestal	4
Kit soporte+peana · Kit support+socle · Kit holder+pedestal	8
Soporte magnético fijo · Support magnétique fixe · Magnetic holder fixed	10

El expositor incluye una tablet con un video explicativo del producto y de los diferentes sistemas de montaje.
Le display comprend une tablette avec une vidéo explicative du produit et les différents systèmes de montage.
The display includes a tablet with an explicative video product and of the different mounting systems.

Mira el video.
Voir le vidéo.
Ver o vídeo.
Watch the video.





SOPORTES Y ESCUADRAS
SUPPORTS ET ÉQUERRES
SUPPORTS AND BRACKETS



Escuadras de acero
Equerres d'acier
Steel brackets

000000 Ref.
Codigo EAN = 8421272 + Ref.



Prueba de resistencia realizada ante notario
Essai constaté par huissier de justice
Strength test undertaken before a notary

ROBUSTO Alta resistencia · Haute résistance · Highly resistant

cm.	Kg MAX. RECOM. 2 UN.		Blanco Blanc White	Negro Noire Black	Bicromatado
18 x 20	300	10	009560	009577	009584
18 x 30	300	10	001267	001281	001304
18 x 40	300	10	001274	001298	001311
30 x 50	500	8	001182	001205	001229



FORTEX · Alta resistencia · Haute résistance · Highly resistant

cm.	Kg MAX. RECOM. 2 UN.		Blanco Blanc White	Plata Argent Silver	Zinc
20 x 25	300	5	009164	009188	009171
20 x 30	300	5	009829	009881	009850
25 x 40	240	5	009836	009898	009867
33 x 50	200	5	009843	009904	009874



FORTEX MINI Alta resistencia
Haute résistance
Highly resistant

cm.	Kg MAX. RECOM. 2 UN.		Blanco Blanc White	Plata Argent Silver	Zinc
10 x 15	240	10	008754	008778	008761
12,5 x 20	240	10	007283	007368	007320
15 x 25	240	10	007290	007375	007337
17,5 x 30	300	10	007306	007382	007344



· Los pesos máximos reflejados en estas páginas han sido testados por FEPRE con carga repartida. La Empresa no se hace responsable del tipo de fijación o resistencia de la pared.
· Les poids maximaux réfléchis sur ces pages ont été testés par FEPRE avec charge distribuée. La Société n'est pas responsable du type de fixation ou de la résistance du mur.
· The specified maximum weights have been tested by FEPRE with distributed load. The Company is not liable for the type of wall mounting or strength.



Escuadras de acero plegables

Equerres d'acier pliées

Folding steel brackets

ABAT-PLAN

Alta resistencia. 2 cm Plegada

Haute résistance. 2 cm pliantes

Highly resistant. 2cm folded

	 Kg MAX. RECOM. 2 UN.		Blanco Blanc White	Gris Plata Gris Argenté Silver Grey	Bicomatado
11 x 20	200	10	036023	036047	
16 x 30	200	10	036030	036054	
40 x 40	400	6	009935	009911	009959
40 x 52	400	6	009942	009928	009966



ABAT-TABLE

Alta resistencia. 2 cm Plegada

Haute résistance. 2 cm pliantes

Highly resistant. 2cm folded

	 Kg MAX. RECOM. 2 UN.		Blanco Blanc White	Gris Plata Gris Argenté Silver Grey
30 X 40	300	6	015431	015455
30 X 52	300	6	015448	015462



Nuevo diseño con travesaño más corto y que proporciona mayor espacio útil.

Nouveau desing avec barre transversale plus courte et offrant plus d'espace utile

New desing whit shorter crossbar and that provides more useful space.



Escuadras de acero
Equerres d'acier
Steel brackets



0,000	Precio en €
000000	

Codigo EAN = 8421272 + Ref.

FEPRE A Granel · En vrac · Bulk

			Bianco Blanc White	Gris Plata Gris Argenté Silver Grey	Negro Noire Black	Bicromatado
3 x 3	-	10	000239	004404	000673	000123
5 x 5	80	10	000246	004411	000680	000130
7,5 x 7,5	54	10	000253	004428	000697	000147
10 x 10	50	10	000260	004435	000703	000154
12,5 x 12,5	30	10	000277	004442	000710	000161
12,5 x 16	100	8	000291	004459	000734	000185
15 x 20	100	8	000307	004466	000741	000192
20 x 28	180	8	000321	004473	000765	000215



FEPRE. Blisters 2/u

			Bianco Blanc White	Gris Plata Gris Argenté Silver Grey	Negro Noire Black	Bicromatado
3 x 3	-	6	010238	014403	010672	010122
5 x 5	80	6	010245	014410	010689	010139
7,5 x 7,5	54	6	010252	014427	010696	010146
10 x 10	50	6	010269	014434	010702	010153



FEPRE. Pack 2/u

			Bianco Blanc White	Gris Plata Gris Argenté Silver Grey	Negro Noire Black	Bicromatado
12,5 x 12,5	30	6	018272	014441	018715	018166
12,5 x 16	100	6	018296	014458	018739	018180
15 x 20	100	6	018302	014465	018746	018197
20 x 28	180	6	018326	014472	018760	018210



- Los blisters y packs se entregan con tornillos y tacos
- Les blisters et packs sont livrés avec visserie
- The blisters and packs come with screws and plugs



Escuadras de acero
Equerres d'acier
 Steel brackets



DUNA **Alta resistencia. Tornillería incluida**
Haute résistance. Visserie comprise
Highly resistant. Screws included

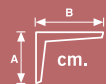

			Blanco Blanc White
10 x 15	40	10	016704
15 x 20	40	10	016711
15,5 x 25	50	10	016728
20,5 x 30	70	10	016735
20,5 x 34,5	100	10	016742

DUNA **Pack 2/u. Tornillería incluida**
Pack 2/u. Visserie fournie
Highly resistant. Screws included.

			Blanco Blanc White
10 x 15	40	5	016995
15 x 20	40	5	017008
15,5 x 25	50	5	017015
20,5 x 30	70	5	017022
20,5 x 34,5	100	5	017039

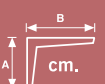

ÓPTIMA

			Blanco Blanc White	Plata mate Argent mat Matt Silver
12,5 x 15	70	10	004756	036306
15 x 20	70	10	004763	036313
20 x 25	60	10	004770	036320
25 x 30	60	10	004787	036337





Escuadras de acero
Equerres d'acier
Steel brackets

000000 Ref.
Codigo EAN = 8421272 + Ref.





PALOMILLA					
			Blanco Blanc White	Gris Gris Gray	Negro Noire Black
7,5 x 10	50	20	001007	001083	039475
10 x 12,5	50	20	001014	001090	039482
12,5 x 15	60	20	001021	001106	039499
15 x 20	60	20	001038	001113	039505
17,5 x 22,5	40	20	001045	001120	046213
20 x 25	40	20	001052	001137	039512
25 x 30	60	20	001069	001144	039529
30 x 35	40	20	001076	001151	039536
35 x 40	56	10	001168	001328	046190
40 x 45	60	10	005838	005845	046206



NOON				
		Blanco Blanc White	Plata Argent Silver	Negro Noire Black
15 x 15	200	004862	004923	004954
20 x 20	200	004879	004930	004961
25 x 25	200	004886	004947	004978



NOON L				
		Blanco Blanc White	Plata Argent Silver	Negro Noire Black
15 x 15	300	016285	016360	016407
20 x 20	300	016292	016377	016414
25 x 25	300	016308	016384	016421



ENFANT COLLECTION



Escuadras de acero infantiles Equerres d'acier infantiles Character steel brackets

EUROPA

		Blanco Blanc White	Amarillo Jaune Yellow	Naranja Orange Orange	Fucsia Fuchsia Fuchsia	Rojo Rouge Red	Azul cielo Blue ciel Sky blue
11 x 15 x 3	50	008143	008198	008174	008167	008150	008181



ÓVALO

		Blanco Blanc White	Plata Argent Silver	Amarillo Jaune Yellow	Naranja Orange Orange
18 x 18 x 6	36	006699	006705	006729	006712



TRIÁNGULO

		Blanco Blanc White	Plata Argent Silver	Negro Noire Black	Amarillo Jaune Yellow	Rojo Rouge Red	Lila Lilas Lilac	Azul cielo Blue ciel Sky blue
18 x 18 x 6	16	006651	036061	006996	036085	007085	036078	007092



Soporte para repisa de radiador · 2/u Support pour tablette radiateur. 2/u Support for radiator shelf. Blister pack of 2



6	040204	Blanco Blanc White
---	--------	--------------------------

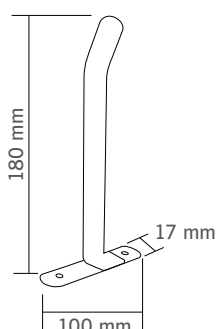



Escuadras de acero ORNAMENTALES
 Equerres d'acier ORNEMENTAUX
 ORNAMENTAL steel brackets



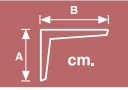

000000 Ref.
 Código EAN = 8421272 + Ref.

ORNAMENT

	 Kg MAX. RECOM. 2 UN.		Bianco Blanc White	Negro Noire Black
10 x 10	100	10	005012	005050
15 x 15	140	10	005029	005067
20 x 20	140	10	005036	005074
25 x 25	160	10	005043	005081



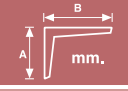

FORJA

	 Kg MAX. RECOM. 2 UN.		Negro Noire Black
200 x 250	120	10	016209
250 x 300	100	10	016216
300 x 350	60	10	016223
350 x 400	60	10	016230

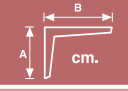

FORJA PLANO

	 Kg MAX. RECOM. 2 UN.		Negro Noire Black
9 x 10	20	10	015059
12,5 x 15	60	10	036245
15 x 20	100	10	036238
20 x 25	80	10	036252





Escuadras de madera
Equerres en bois
Wood brackets



FORESTA P

	 Kg MAX. RECOM. 2 UN.		Haya Hêtre Beech
10 x 15	34	10	005500
15 x 20	26	10	005517
20 x 25	20	10	005524
25 x 30	12	10	005692



FEPRE M

	 Kg MAX. RECOM. 2 UN.		Haya Hêtre Beech
11 x 14	120	10	005302
15 x 20	80	10	005326
20 x 25	100	10	005241
25 x 30	60	10	005258



RUSTIC

	 Kg MAX. RECOM. 2 UN.		Blanco Blanc White	Negro Noir Black	Haya Hêtre Beech	Nogal Noyer Walnut
17 x 23	150	10	047746	047715	005180	016650
23 x 28	160	10	047753	047722	005197	016667
28 x 32	160	10	047760	047739	005203	016674



ONDULADA

	 Kg MAX. RECOM. 2 UN.		Haya Hêtre Beech
13,5 x 15,5	80	10	016681
16,5 x 19,5	80	10	016698





Escuadras Decorativas de acero
Equerres Décoratives d'acier
Steel decorative brackets



NODE

Diagram A B cm.	Kg MAX. RECOM. 2 UN.	Box	Grís Gris Gray	Bronze ant. Bronze ant. Bronze ant.
14,5 x 14,5	40	6	045551	045537
19,5 x 19,5	40	6	045568	045544



AIRY

Diagram A B cm.	Kg MAX. RECOM. 2 UN.	Box	Negro Noire Black	Grís Gris Gray	Bronze ant. Bronze ant. Bronze ant.
14,5 x 14,5	12,5	6	045575	045599	045612
19,5 x 19,5	12,5	6	045582	045605	045629



STAIR

Diagram A B cm.	Kg MAX. RECOM. 2 UN.	Box	Plata mate Argent mat Matt Silver
14,5 x 14,5	30	6	045636
19,5 x 19,5	40	6	045643



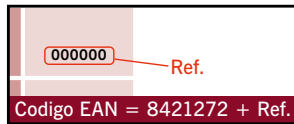

Escuadras de acero
Equerres d'acier
 steel brackets



MINI CURVE

			Blanco Blanc White	Plata mate Argent mat Matt Silver	Cromo Chrome Chrome
14 x 14	30	6	045667	045650	045674

CURVE

			Blanco Blanc White	Plata mate Argent mat Matt Silver	Negro Noire Black
24 x 24	40	6	045698	045681	045704



TUCSON

			Blanco Blanc White	Negro Noire Black
20 x 15	10	6	015608	015639
25 x 15	10	6	015615	015646
30 x 15	10	6	015622	015653



ARMS

			Blanco Blanc White	Negro Noire Black
15 x 20	10	6	015806	015813





ESTANTES Y CLIPS TABLETTES ET CLIPS SHELVES AND CLIPS



Clips para estantes
Clips pour tabletterie
Lock clips for shelves



SOFT MICROCLIP					
cm	Kg MAX. RECOM.	Blanco Blanc White	Inox.	Plata mate Argent mat Matt Silver	Negro Noire Black
0,3 - 0,8	10	046084	046107	046091	046114



SOFT JUNIORCLIP					
cm	Kg MAX. RECOM.	Blanco Blanc White	Inox.	Plata mate Argent mat Matt Silver	Negro Noire Black
0,3 - 1,8	25	045964	045988	045971	045995



SOFT MIDICLIP					
cm	Kg MAX. RECOM.	Blanco Blanc White	Inox.	Plata mate Argent mat Matt Silver	Negro Noire Black
0,4 - 2,8	30	046008	046022	046015	



SOFT SENIORCLIP					
cm	Kg MAX. RECOM.	Blanco Blanc White	Inox.	Plata mate Argent mat Matt Silver	Negro Noire Black
0,4 - 4,2	60	046046	046060	046053	046077

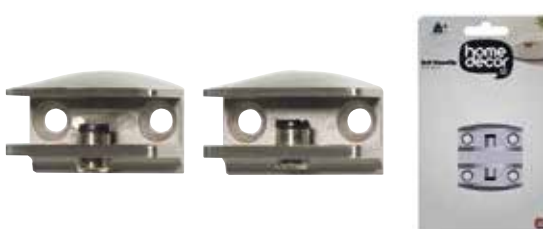

SOFT GLASSCLIP		
cm	Kg MAX. RECOM.	Nickel
0,6 - 0,8	10	046176





Estantes de cristal
Tablettes en verre
Glass shelves



Rinconera · D'angle · Corner shelf



	0,6	0,6
--	-----	-----

		Transp	Mate Mate Matt-finished
25 x 25	3	037662	037709

Rectangular · Rectangulaire · Rectangular

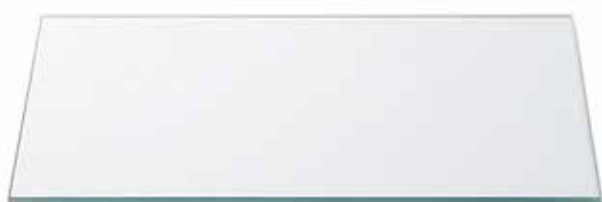

	0,6	0,6
--	-----	-----

		Transp	Mate Mate Matt-finished
40 x 15	3	037679	
60 x 15	3	037686	037723

2 cantos redondos · 2 bords arrondis · 2 rounded edges

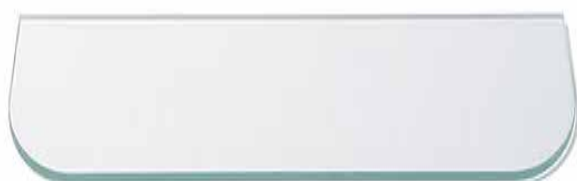

	0,6	0,6
--	-----	-----

		Transp	Mate Mate Matt-finished
60 x 15	3	037693	037730



Estantes de MDF preperforados
Tablettes en MDF prépercées
MDF shelves pre holed

000000 Ref.
Codigo EAN = 8421272 + Ref.

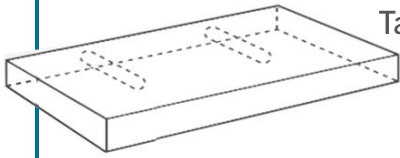

Rinconera · D'angle · Corner shelf

		1,8	1,8	1,8	1,8
		Blanco Blanc White	Wenge	Roble blanco Chêne blanc Oak	Antracita Anthraxite
25 x 25	3	038508	038560	017183	017152
35 x 35	3	038515			



Rectangular · Rectangulaire · Rectangular

		1,8	1,8	1,8	1,8
		Blanco Blanc White	Wenge	Roble blanco Chêne blanc Oak	Antracita Anthraxite
60 x 15	3	038584	038690	017428	017381
60 x 25	3	038591	038706	017190	017169
80 x 15	3	038607	038997	017435	017398
80 x 25	3	038614	038713	017206	017176



Rondo · Rondo · Rondo

		1,8	1,8	1,8	1,8
		Blanco Blanc White	Wenge	Roble blanco Chêne blanc Oak	Antracita Anthraxite
60 x 25	3	017442	038874	017442	017404
80 x 25	3	017411	038898	017459	017411



SOFT CLAMP
Soportes de fijación invisible
Supports de fixation invisible
Invisible fastening brackets

	Ø cm	Kg MAX. RECOM. 2 UN.		ALU
12 x 12	1,2	10	6	047586



Estantes Tamborados HD. Fijación invisible
 Tablette alvéolaire HD. Fixation invisible
 HD hollow core shelves. Floating



Estantes Tamborados HD. Acabado de PVC · Tablette alvéolaire HD. Finition PVC · HD hollow core shelves. PVC coating

			4	4	4	4	4	4	4	4	4	4	4	
			Blanco Blanc White	ALU	Antracita Anthracite	Haya Hêtre Beech	Roble Chêne Oak	Roble blanco Chêne blanc White oak	Roble gris Chêne gris Gray oak	Roble viejo Chêne vieux Old oak	Cerezo Cerise Cherry	Wenge	Verde Vert Green	Fucsia Fuchsia Fuchsia
25 x 25	5	3	046312	047470	017213	045063	045179	047678	047777	047807	046268	045247	047609	045285
60 x 25	25	3	045315	045216	017220	045070	045186	047685	047784	047814	045100	045254	047616	045292
80 x 25	25	3	045322	045223	017237	045087	045193	047692	047791	047821	045117	045261	047623	045513
120 x 25	25	3	046329	045230	017305	045094	045209	017312	017329	017336	045124	045278		
60 x 20	25	3	005807											
80 x 20	25	3	045858		047456							045889		

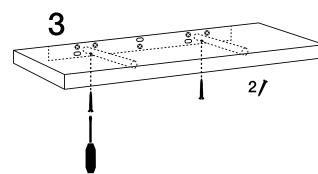
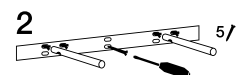
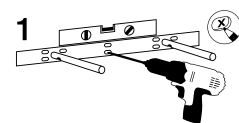
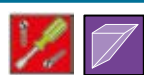

Tornillos de fijación a pared no incluidos.
 Vis de fixation au mur pas inclus.
 Fixing screw wall not included.



Estantes Tamborados HD. Fijación invisible
 Tablette alvéolaire HD. Fixation invisible
 HD hollow core shelves. Floating

000000 Ref.
 Codigo EAN = 8421272 + Ref.



JUNIOR Acabado de PVC · Finition PVC · PVC coating

		4		4		4		4		4	
						Blanco Blanc White	Negro Noire Black	Roble blanco Chêne blanc White oak	Wengé	Fucsia FUCHSIA Fuchsia	Platacho Platache Platachio
30 x 15	5	3	037464	037518	017343	037495	037501	037471			



Lacado
Laqué
Laquered



Estantes lacados · Tablettes laquées · Shelves lacquered

		4	
25 x 25	5	3	045438
60 x 25	25	3	045445
80 x 25	25	3	045452
120 x 25	25	3	045469



Alto brillo
Brillant
Glossy



Estantes de alto brillo · Tablettes brillants · High gloss shelves

		4		4		4	
				Blanco Blanc White	Gris Gris Gray	Negro Noire Black	
25 x 25	25	3	047319	047333	047326		
60 x 25	25	3	045476	047340	045490		
80 x 25	25	3	045483	047357	045506		



Estantes Tamborados HD. Fijación invisible
 Tablette alvéolaire HD. Fixation invisible
 HD hollow core shelves. Floating



Estantes con cantos redondos · Recubrimiento de PVC
 Bords arrondis. Finition PVC
 Rounded-edge shelves. PVC coating

		4		4		4		4	
		cm							
			Blanco Blanc White	Negro Noire Black	Fucsia Fuchsia FUCSIA	Pistachio Pistache Pistachio			
60 x 25	25	3	037525	037570	037563	037532			
80 x 25	25	3	037402						



Lacado
Laqué
Laquered

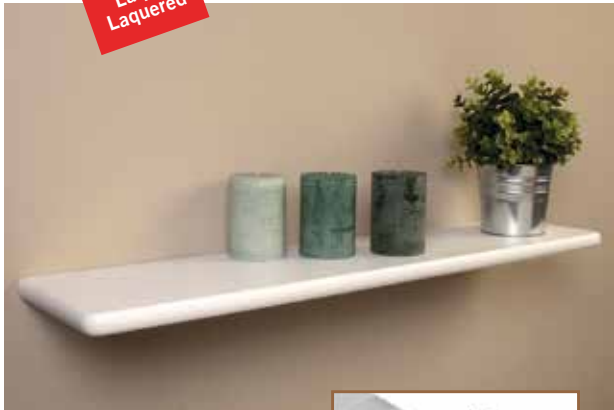

Estantes de MDF lacados · Cantos redondeados
 Tablettes MDF laqué. Bords arrondis
 Lacquered MDF shelves. Rounded edges

		2,2	
		cm	
			Blanco Blanc White
60 x 19	10	3	045407
80 x 19	10	3	045414
100 x 19	10	3	045421



Sujetalibros · Serre-livres · Bookends

		3,8	
		cm	
			Gris Gris Gray
60 x 19		5	041539





Estantes HD. Fijación invisible
Tablette HD. Fixation invisible
HD floating shelf.

000000 Ref.
Codigo EAN = 8421272 + Ref.

Lacado
Laqué
Laquered



Con cajón integrado · Avec tiroir · With drawer

		4	4	4
		Blanco Blanc White	Negro Noire Black	Roble blanco Chêne blanc White oak
48 x 10 x 25	10	017350	045056	017350



Lacado
Laqué
Laquered



Con cajón integrado · Avec tiroir · With drawer

		4	4
		Blanco Blanc White	Negro Noire Black
80 x 5 x 25	15	045025	017367



ZIG ZAG. Acabado de PVC. Finition PVC · PVC coating

		1,8	1,8	1,8	1,8	1,8	1,8	
		Blanco Blanc White	Negro Noire Black	Roble blanco Chêne blanc White oak	Wenge	Naranja Orange Orange	Fucsia Fuchsia Fuchsia	Verde Vert Green
59 x 12 x 12	5	037372	047395	017374	037396	037365	037358	047647



Lacado
Laqué
Laquered



Estantes HD. Fijación invisible
Tablette HD. Fixation invisible
HD floating shelf.

U RECTO. Lacado · Laquée · Lacquered

		2	2	2	2	2	
		Blanco Blanc White	Negro Noire Black	Roble blanco Chêne blanc White oak	Wengé PVC	Verde Vert Green	Lila Lilas Lilac
60 x 10 x 15	10	037105	047593	017299	037112	047654	037129

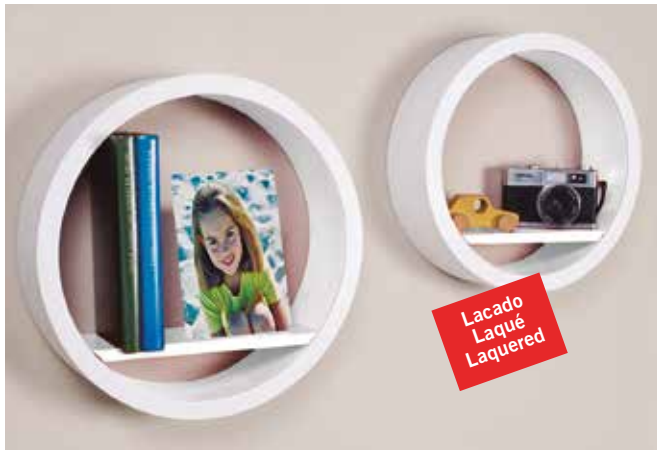

Lacado
Laqué
Laquered

SPHERIC. Lacado · Laquée · Lacquered

		2
		Blanco Blanc White
34,5-29,5 x 9	5	037808

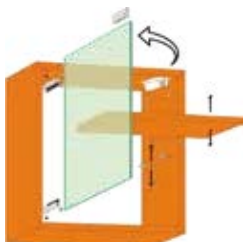

CABINET.

Acabado PVC · Finition PVC · PVC coating

		1,2	1,2
		Blanco Blanc White	Wengé
30 x 30 x 12	10	046435	046466



- Puerta reversible de vidrio con cierre imantado. Estante regulable.
- Porte réversible en verre avec fermeture magnétique. Tablette réglable.
- Reversible glass door with magnetic closure. Adjustable shelf

Estantes HD. Fijación invisible
Tablette HD. Fixation invisible
HD floating shelf.



TRIPLE CUBO RECTO.

Acabado de PVC. Finition PVC • PVC coating

	5 cm	1,2	1,2	1,2	1,2	1,2	1,2	1,2	1,2	1,2	1,2	1,2	1,2
		Blanco Blanc White	ALU	Antracita Anthracite	Negro Noire Black	Naranja Orange	Verde Vert Green	Fucsia Fuchsia	Roble Chêne Oak	Roble blanco Chêne blanc Oak	Roble gris Chêne gris Gray oak	Roble viejo Chêne vieux Old oak	Wenge
30 x 30 x 12	5			017268	047371	045827	047630	045841	045803	017275	017244	017251	045957
27 x 27 x 12	5	045810	047364										
24 x 24 x 12	5												



TRIPLE CUBO RECTANGULAR.

Acabado de PVC. Finition PVC • PVC coating

	5 cm	1,2	1,2
		Blanco Blanc White	Roble blanco Chêne blanc Oak
30 x 60 x 15	5		017275
26,5 x 38 x 15	5	047388	
26,5 x 17 x 15	5		



Lacado
Laqué
Laquered



TRIPLE CUBO RONDO. Lacado • Laquée • Lacquered

	5 cm	1,5	1,5
		Blanco Blanc White	Negro Noire Black
30 x 30 x 10	5		036948
25 x 25 x 10	5	037037	
20 x 20 x 10	5		





SISTEMA DE AGARRE TWIST
SYSTÈME DE PRISE TWIST
GRIPPING SYSTEM TWIST





000000 Ref.
Codigo EAN = 8421272 + Ref.



TWIST

43 cm.	20	047036	047043	047050	047067	047074	047081
86 cm.	20	047098	047104	047111	047128	047135	047142



ROLLER FOR TWIST

10	047159			
----	--------	--	--	--

EXPOSITOR · EXPOSITEUR · DISPLAY

COMPOSICIÓN · COMPOSITION · COMPOSITION

Expositor · Expositeur · Display 8421272047166		Cant. Expos.
43 cm.	86 cm.	
		40 / 40
		40 / 40
		40 / 40
		40 / 40
		40 / 40
		40 / 40
		10



Mira el video.
Voir le vidéo.
Ver o vídeo.
Watch the video.



El expositor incluye una tablet con un video explicativo del producto y aplicaciones.
Le display comprend une tablette avec une vidéo explicative du produit et applications.
The display includes a tablet with an explicative video product and applications.





GUÍAS Y CARTELAS / HOGAR
CONSOLES ET CRÉMAILLÈRES / MAISON
RAIL GUIDES AND BRACKETS / HOME





000000 Ref.
Codigo EAN = 8421272 + Ref.

CombiSystem

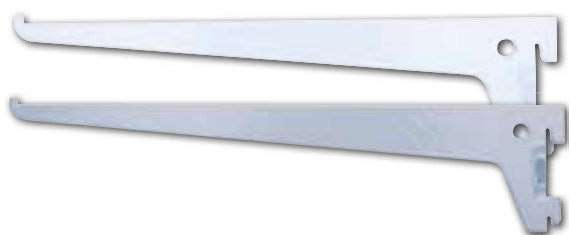

Cartelas simples · Consoles simples · Single brackets

Dim. cm	Kg MAX. RECOM. 2 UN.		Blanco Blanc White	Plata Argent Matt
15	40	20	038102	038171
20	40	20	038119	038188
25	40	20	038126	038195
30	40	20	038133	038201
35	40	20	038140	038218
40	40	20	038157	038225
50	40	10	038164	038232



Cartelas dobles · Consoles dobles · Double brackets

Dim. cm	Kg MAX. RECOM. 2 UN.		Blanco Blanc White	Plata Argent Matt
17	55	10	038003	038058
22	55	10	038010	038065
27	55	10	038027	038072
37	55	10	038034	038089
47	55	10	038041	038096



12 Soportes para estantes 12 Supports pour tablettes 12 Shelf supports

Dim. cm	Kg MAX. RECOM. 2 UN.		Plata Argent Matt
2.1x1,13x1.28	55	10	047838





Guías simples. Packs de 2/u
Crémaillères simples Pack 2/u
 Single rail guides. Packs of 2 guides

Dim. cm		Blanco Blanc White	Plata Argent Matt
50	6 pack de 2	038324	038362
100	6 pack de 2	038331	038379
150	6 pack de 2	038348	038386
200	6 pack de 2	038355	038393



Guías dobles. Packs de 2/u
Crémaillères doubles Pack 2/u
 Double rail guides. Packs of 2 guides

Dim. cm		Blanco Blanc White	Plata Argent Matt
50	6 pack de 2	038249	038287
100	6 pack de 2	038256	038294
150	6 pack de 2	038263	038300
200	6 pack de 2	038270	038317





000000 Ref.
Codigo EAN = 8421272 + Ref.

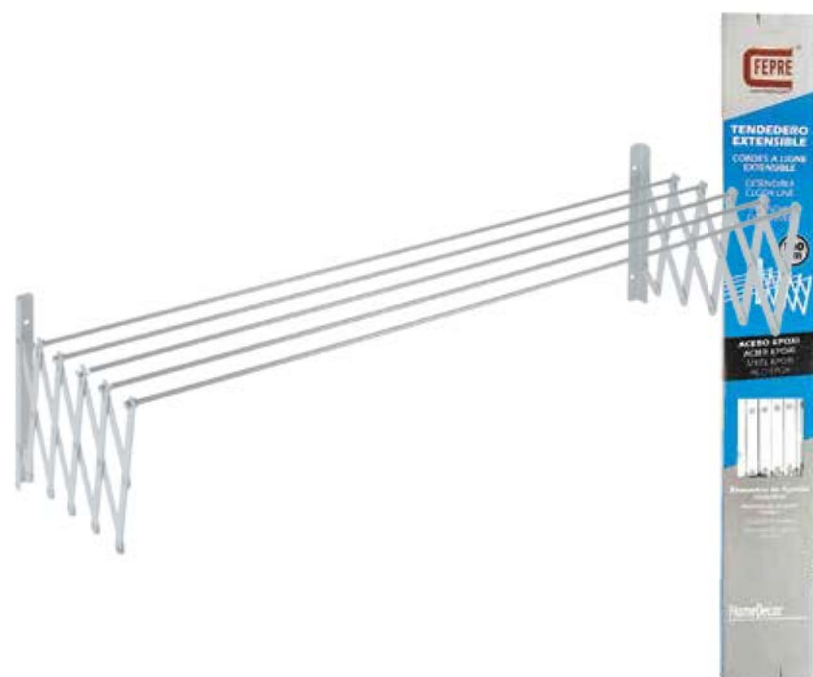

Acero · Acier · Steel

Pintado Epoxi blanco. 5 varillas.
Peint epoxy blanc. 5 tiges.
White epoxy painted. 5 rods.

Dim. cm	Blanco Blanc White
80	046909
100	046916
120	046923
140	046930
160	046947

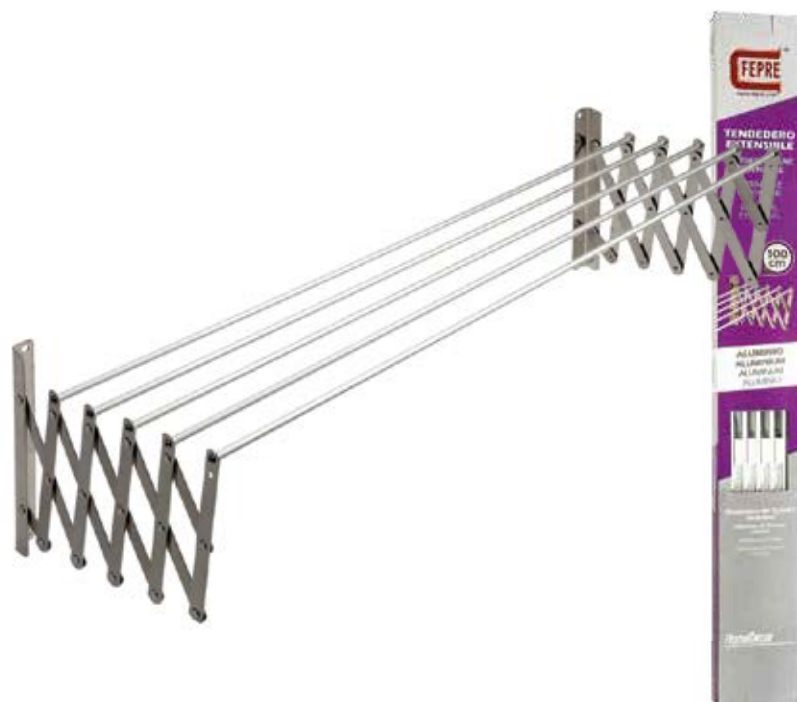

Aluminio · Aluminium · Aluminium

5 varillas · 5 tiges · 5 rods

Dim. cm	Natural Naturel Natural
80	046954
100	046961
120	046978
140	046985
160	046992





Cajón extraíble con guías
Tiroir amovible avec guides
Removable drawer with guides

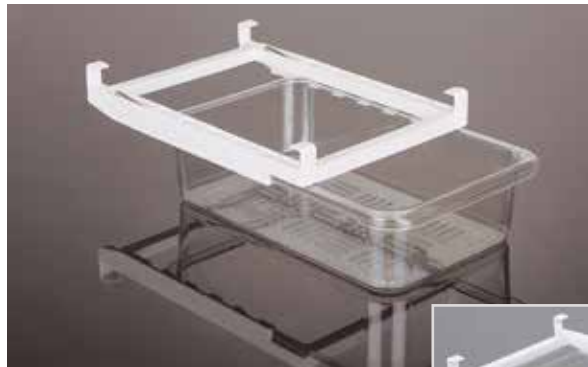

NEW

Dim.
cm
30 x 19 x 7

016537



Huevera • Coquetier • Egg-cup

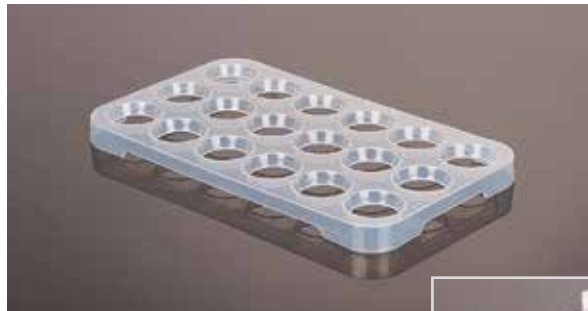

NEW

Dim.
cm
26,5 x 15,5

016551



Cajón extensible • Tiroir extensible • Extendable drawer



NEW

Dim.
cm
20/28 x 16 x 6

016544





PATAS PARA MUEBLES
PIEDS POUR MEUBLES
LEGS FOR FURNITURE

000000 Ref.
Codigo EAN = 8421272 + Ref.

Patas metálicas
Pieds en métal
Metallic legs



Cuadradas · Carrées · Square

cm	a b cm	Blanco Blanc White	Negro Noire Black	Plata mate Argent mat Matt Silver	Cromo Chrome Chrome	Limit. Inox.
10	2,5 x 2,5	022811	022828	022835	022842	022859
15	2,5 x 2,5	022866	022873	022880	022897	022903
20	2,5 x 2,5	022910	022927	022934	022941	022958
30	2,5 x 2,5	022965	022972	022989	022996	023009
40	2,5 x 2,5	023016	023023	023030	023047	023054
70	2,5 x 2,5	023061	023078	023085	023092	023108
80	2,5 x 2,5	023115	023122	023139	023146	023153



Redondas · Rondes · Circulars

cm	∅ cm	Blanco Blanc White	Negro Noire Black	Plata mate Argent mat Matt Silver	Cromo Chrome Chrome	Limit. Inox.
10	3	023160	023177	023184	023191	023207
15	3	023214	023221	023238	023245	023252
20	3	023269	023276	023283	023290	023306
30	3	023313	023320	023337	023344	023351
40	3	023368	023375	023382	023399	023405
70	3	023412	023429	023436	023443	023450
80	3	023467	023474	023481	023498	023504



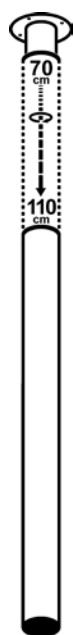

Extensibles · Extensibles · Extendables

cm	∅ cm	Plata mate Argent mat Matt Silver	Cromo Chrome Chrome
70 - 110	6	023627	023610

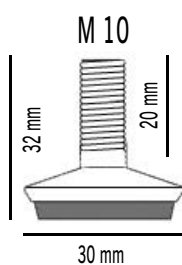

Pies niveladores · Butes réglables · Adjustable screw

cm	∅ cm	ALISTER	Cromo Chrome Chrome
1 a 2,5	M - 1	Pack 4/u.	023634







PROTECCIÓN VEHÍCULOS
PROTECTION VOITURE
VEHICLE PROTECTORS

FEPRE CAR

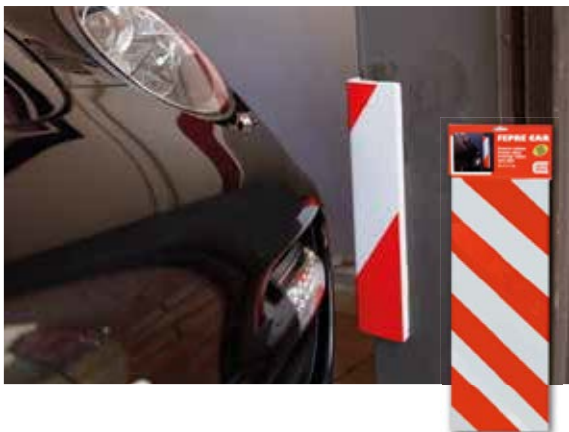
000000 Ref.
Codigo EAN = 8421272 + Ref.



Protector de columna en esquina
Reflectante. Con adhesivo extrafuerte
 Protecteur colonne en angle
 Réflectant. Adhésif extra fort
 Corner pillar protector
 Reflective. With extra strong adhesive

Dim. cm		
35 x 15	1,5	039543



Protector frontal
Reflectante. Con adhesivo extrafuerte
 Protecteur frontal
 Réflectant. Adhésif extra fort
 Front protector
 Reflective. With extra strong adhesive

Dim. cm		
18 x 28	4,5	039550



Protector lateral
Reflectante. Con adhesivo extrafuerte
 Protecteur latérale
 Réflectant. Adhésif extra fort
 Side protector
 Reflective. With extra strong adhesive

Dim. cm		
36 x 8	1,5	039567



FEPRE CAR



Protector para columna redonda
Reflectante. Con adhesivo extrafuerte
 Protecteur colonne ronde
 Réflétant. Adhésif extra fort
 Protector for circular pillar
 Reflective. With extra strong adhesive

Dim. cm		
30 x 38	1,5	039574



Protector universal. Múltiples usos
Con adhesivo extrafuerte
 Protecteur universel. Usages multiples
 À couper Adhésif extra fort
 Universal protector. Multiple use.
 Can be cut. With extra strong adhesive

Dim. cm		
20 x 200	0,5	039581



Tope para rueda
Reflectante. Con adhesivo extrafuerte
 Butoirs de parking
 Réflétant. Adhésif extra fort
 Wheel stopper.
 Reflective. With extra strong adhesive

Dim. cm		
39 x 23	5	039598





IMPLANTACIONES
IMPLANTATIONS
IMPLANTATIONS

Implantación Rejillas
 Implantation Grilles
 Grilles Implantation

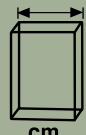
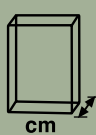
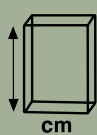

Ref. VENT C.C.

			
65	45	200	

- Expositor Incluido.
- Présentoir compris.
- Stand included.

Implantación Rejillas
 Implantation Grilles
 Grilles Implantation

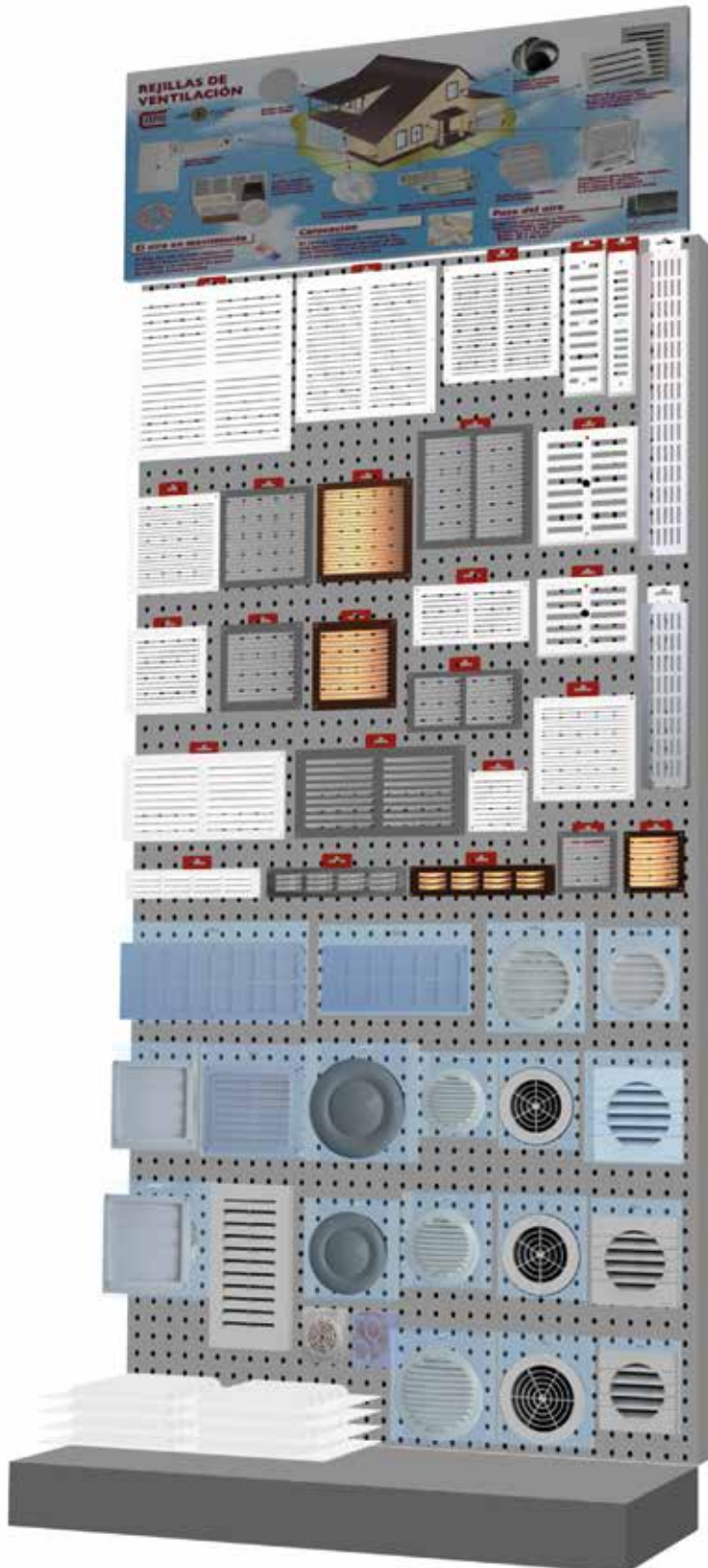

Ref. R-1.

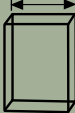
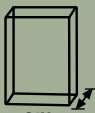
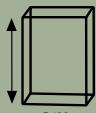
 cm	 cm	 cm	
100	40	200	

- Góndola no incluida. Cartelería incluida.
- Gondole pas compris Affiche compris.
- Stand not included. Poster included.

Implantación Rejillas
 Implantation Grilles
 Grilles Implantation



Ref. R-2.

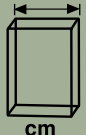
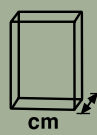
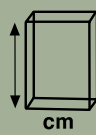

		
130	40	200

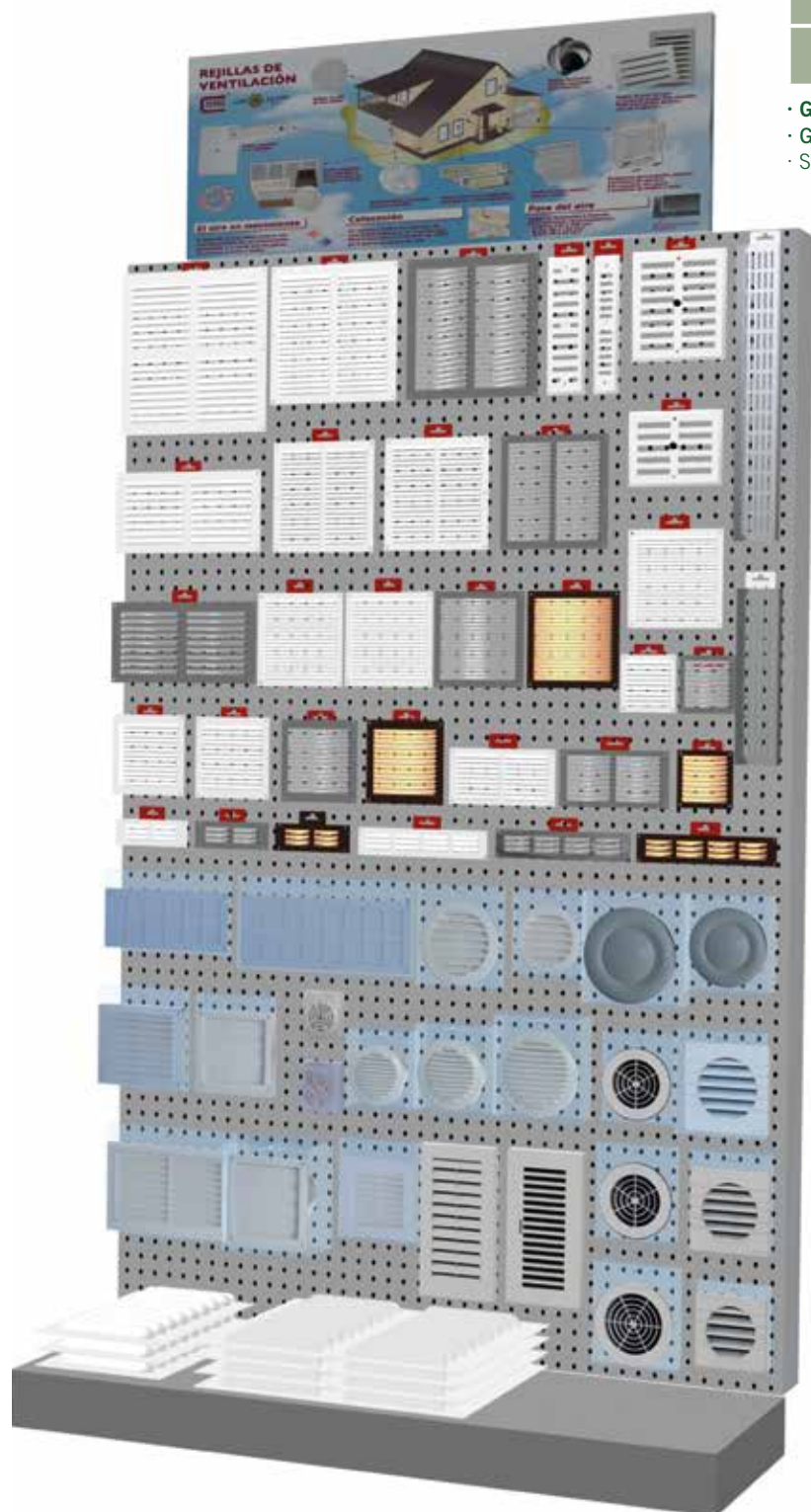
- Góndola no incluida. Cartelería incluida.
- Gondole pas compris Affiche compris.
- Stand not included. Poster included.

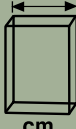

Implantación Rejillas
 Implantation Grilles
 Grilles Implantation

Ref. R-3.

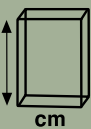
			
200	40	200	

- Góndola no incluida. Cartelería incluida.
- Gondole pas compris Affiche compris.
- Stand not included. Poster included.



Implantación Rejillas
 Implantation Grilles
 Grilles Implantation



Ref. R-4.



260	40	200

- Góndola no incluida. Cartelería incluida.
- Gondole pas compris Affiche compris.
- Stand not included. Poster included.

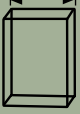

Implantación Rejillas
 Implantation Grilles
 Grilles Implantation

Ref. R-5.

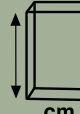
		
cm	cm	cm
300	40	200

- Góndola no incluida. Cartelería incluida.
- Gondole pas compris Affiche compris.
- Stand not included. Poster included.



Implantación Tubos y Extractores
 Implantation Tubes et Extracteurs
 Pipes and Extractors Implantation



Ref. TBE-1.

100	40	200

- Góndola no incluida. Cartelería incluida.
- Gondole pas compris Affiche compris.
- Stand not included. Poster included.



Implantación Tubos y Extractores
 Implantation Tubes et Extracteurs
 Pipes and Extractors Implantation

Ref. TBE-2.

cm	cm	cm	
130	40	200	

- Góndola no incluida. Cartelería incluida.
- Gondole pas compris Affiche compris.
- Stand not included. Poster included.



Implantación Tubos y Extractores
 Implantation Tubes et Extracteurs
 Pipes and Extractors Implantation



Ref. TBE-3.



200	40	200

- Góndola no incluida. Cartelería incluida.
- Gondole pas compris Affiche compris.
- Stand not included. Poster included.

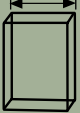

Implantación Extracción de humos
Implantation Tubes et Extracteurs
 Smoke extraction Implantation

Ref. AFS-100.

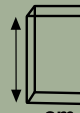
 cm	 cm	 cm	
100	40	200	

- Góndola no incluida.
- Gondole pas compris.
- Stand not included.

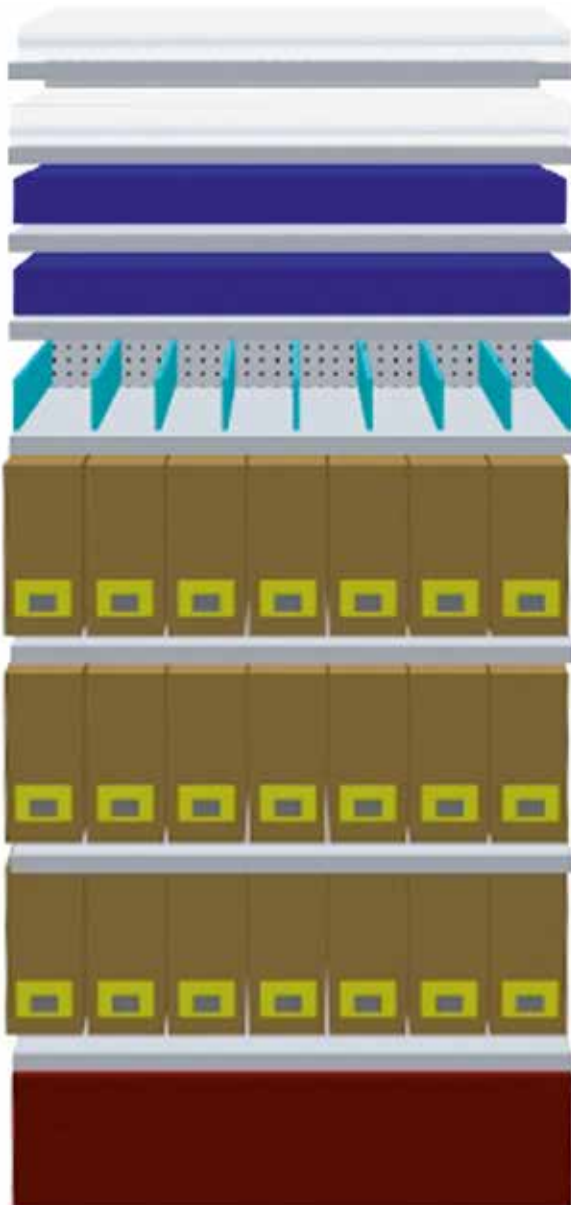

Implantación Extracción de humos
 Implantation Tubes et Extracteurs
 Smoke extraction Implantation

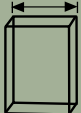
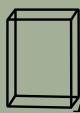
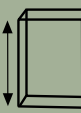

Ref. AFS-130-E.

 cm	 cm	 cm	Ref.
128	40	195	

- Expositor Incluido.
- Présentoir compris.
- Stand included.





Implantación Extracción de humos
Implantation Tubes et Extracteurs
 Smoke extraction Implantation

Ref. AFS-130.

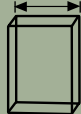
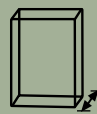
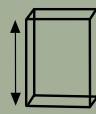
			
130	40	200	

- Góndola no incluida.
- Gondole pas compris.
- Stand not included.

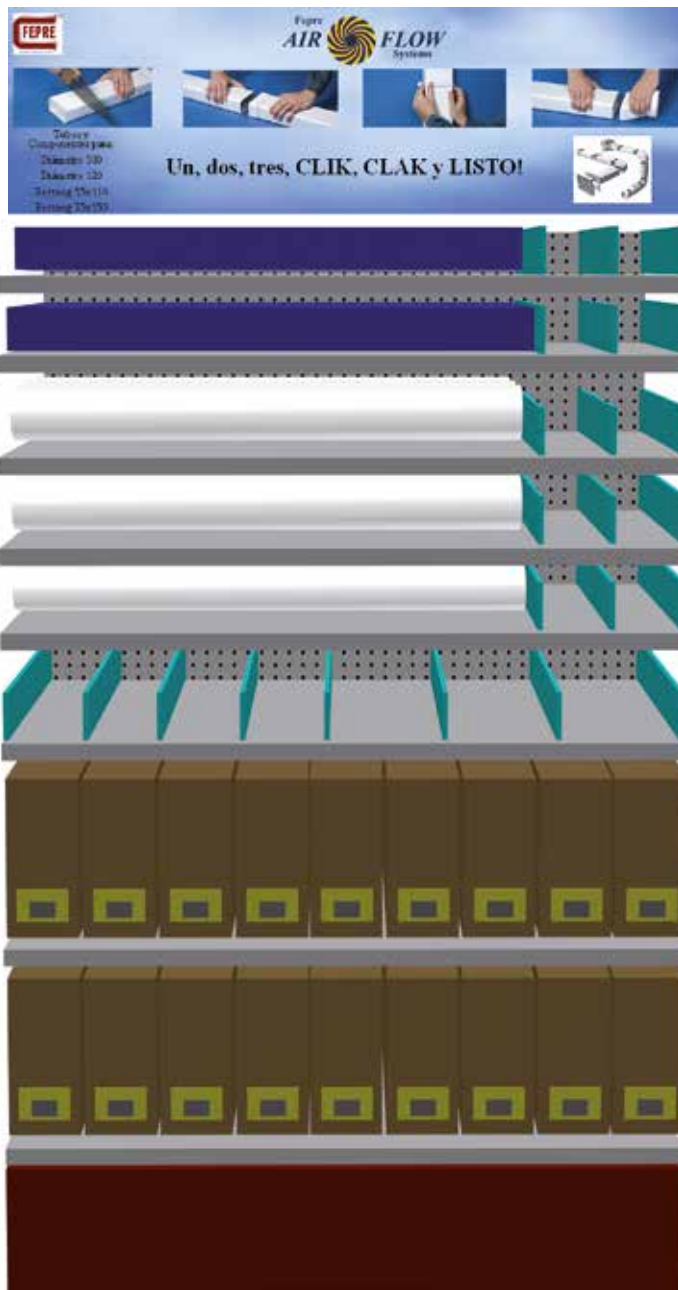

Implantación Extracción de humos
 Implantation Extracción de humos
 Smoke extraction Implantation



Ref. AFS-200.

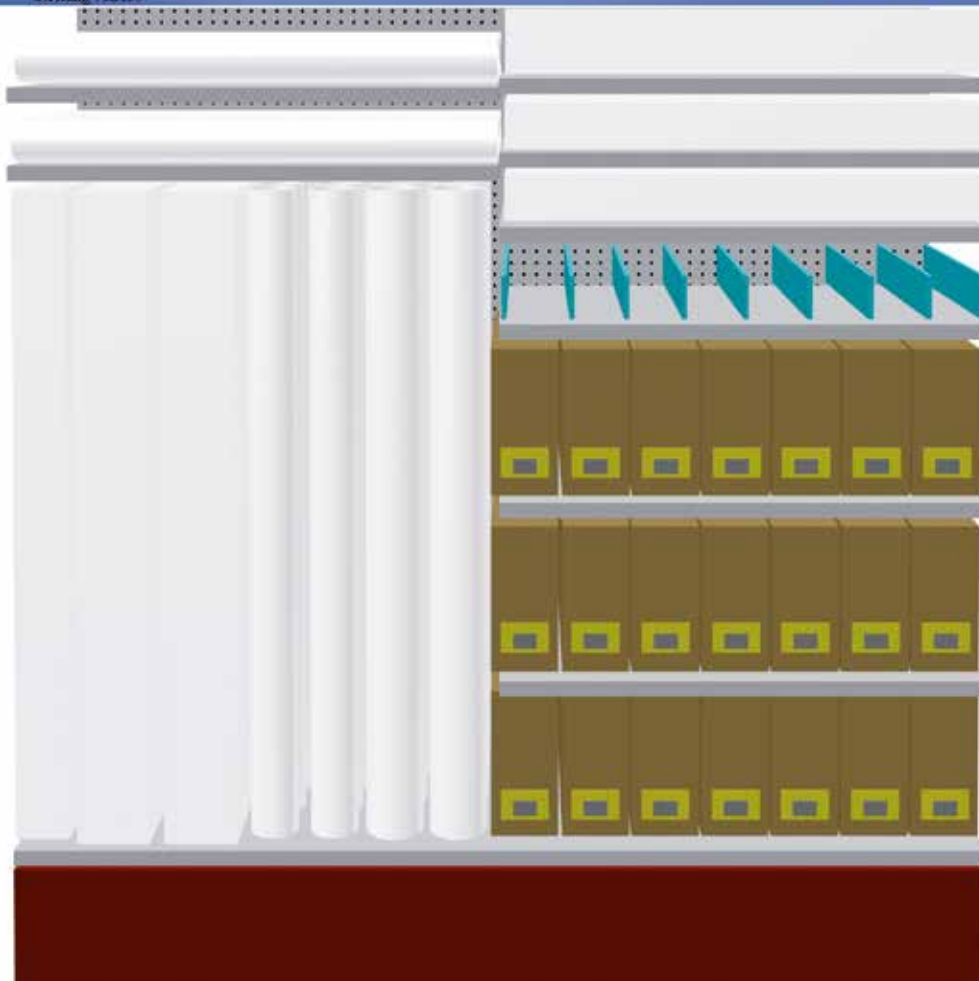

200	40	200	

- Góndola no incluida.
- Gondole pas compris.
- Stand not included.



Implantación Escuadras
 Implantation Équerres
 Brackets Implantation

Ref. E2.

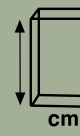
		
100	40	200

- Góndola y panel no incluidos.
- Gondole et panneau pas compris.
- Stand and panel non included.

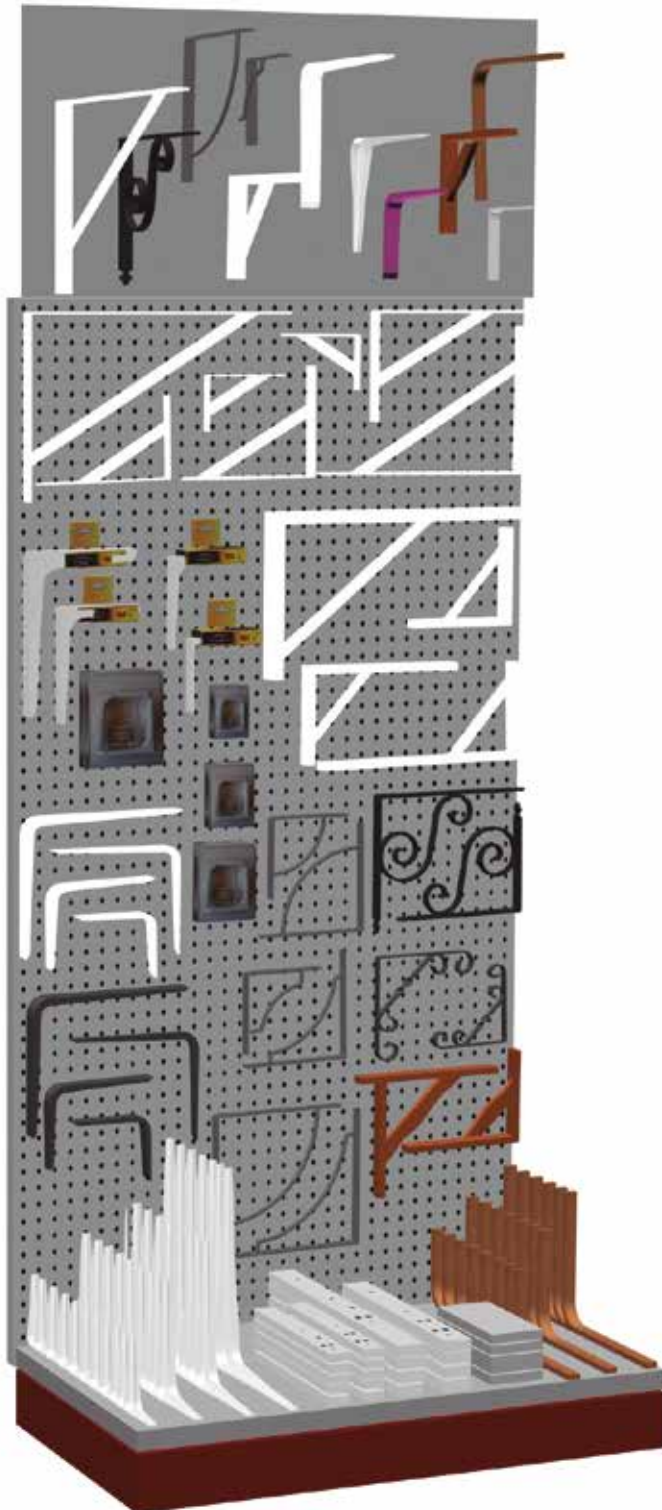

Implantación Escuadras
 Implantation Équerres
 Brackets Implantation

Ref. E3.

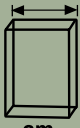
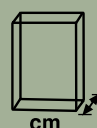
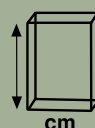
		
130	40	200

- Góndola y panel no incluidos.
- Gondole et panneau pas compris.
- Stand and panel non included.

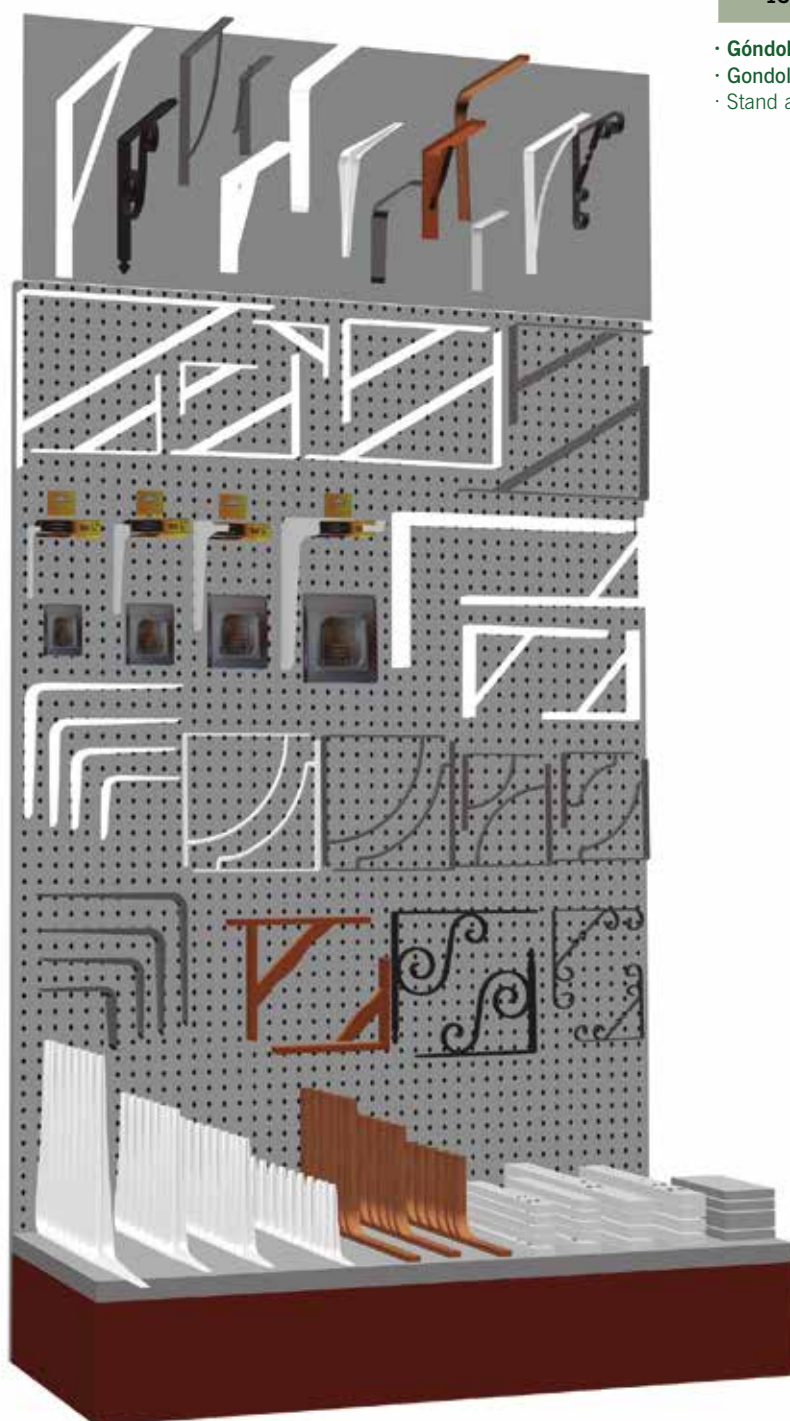



Implantación Escuadras
 Implantation Équerres
 Brackets Implantation

Ref. E4.

cm	cm	cm	
200	40	200	

- Góndola y panel no incluidos.
- Gondole et panneau pas compris.
- Stand and panel non included.

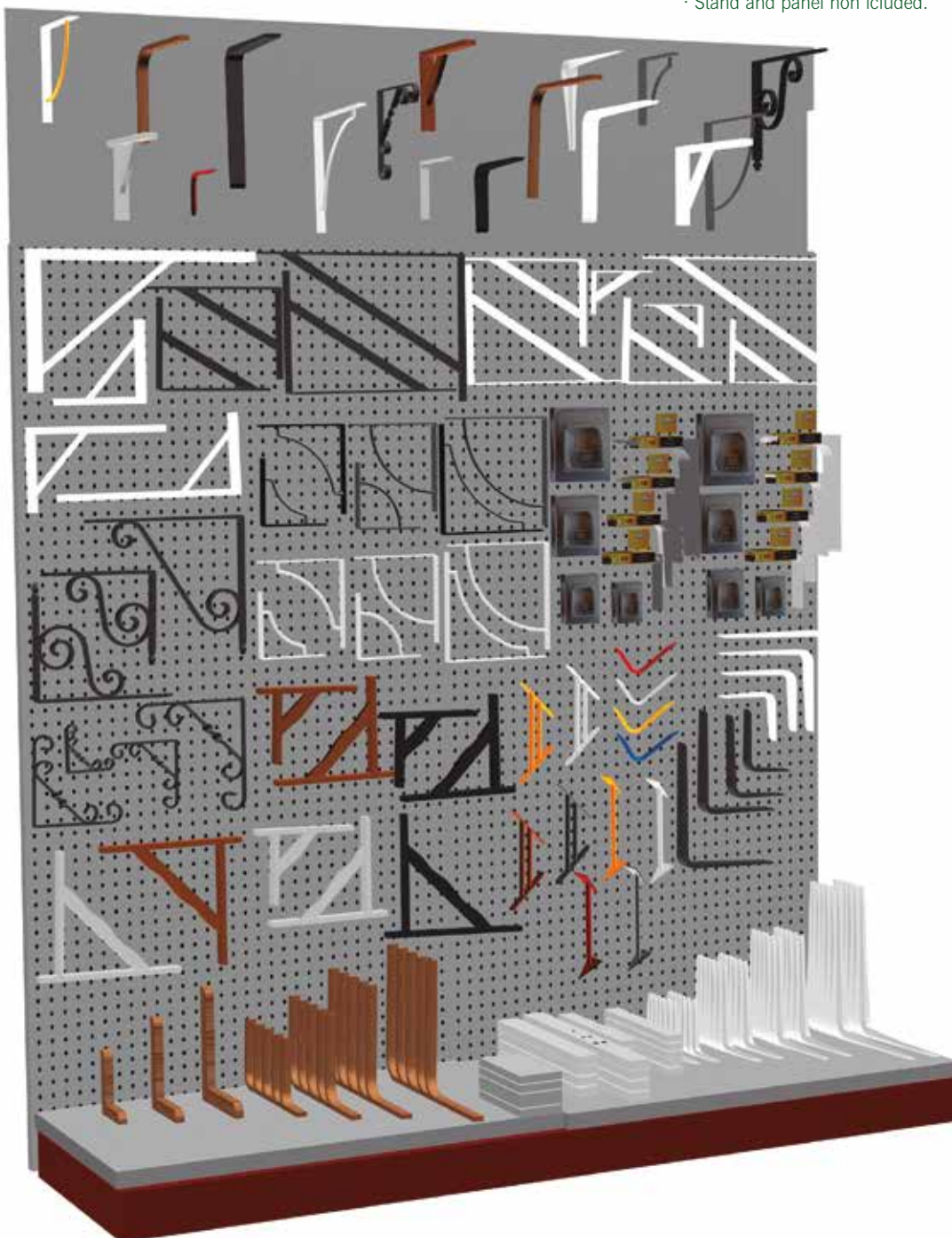

Implantación Escuadras
 Implantation Équerres
 Brackets Implantation

Ref. E5.

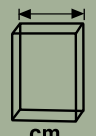
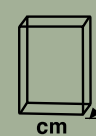
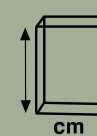
		
260	40	200

- Góndola y panel no incluidos.
- Gondole et panneau pas compris.
- Stand and panel non included.

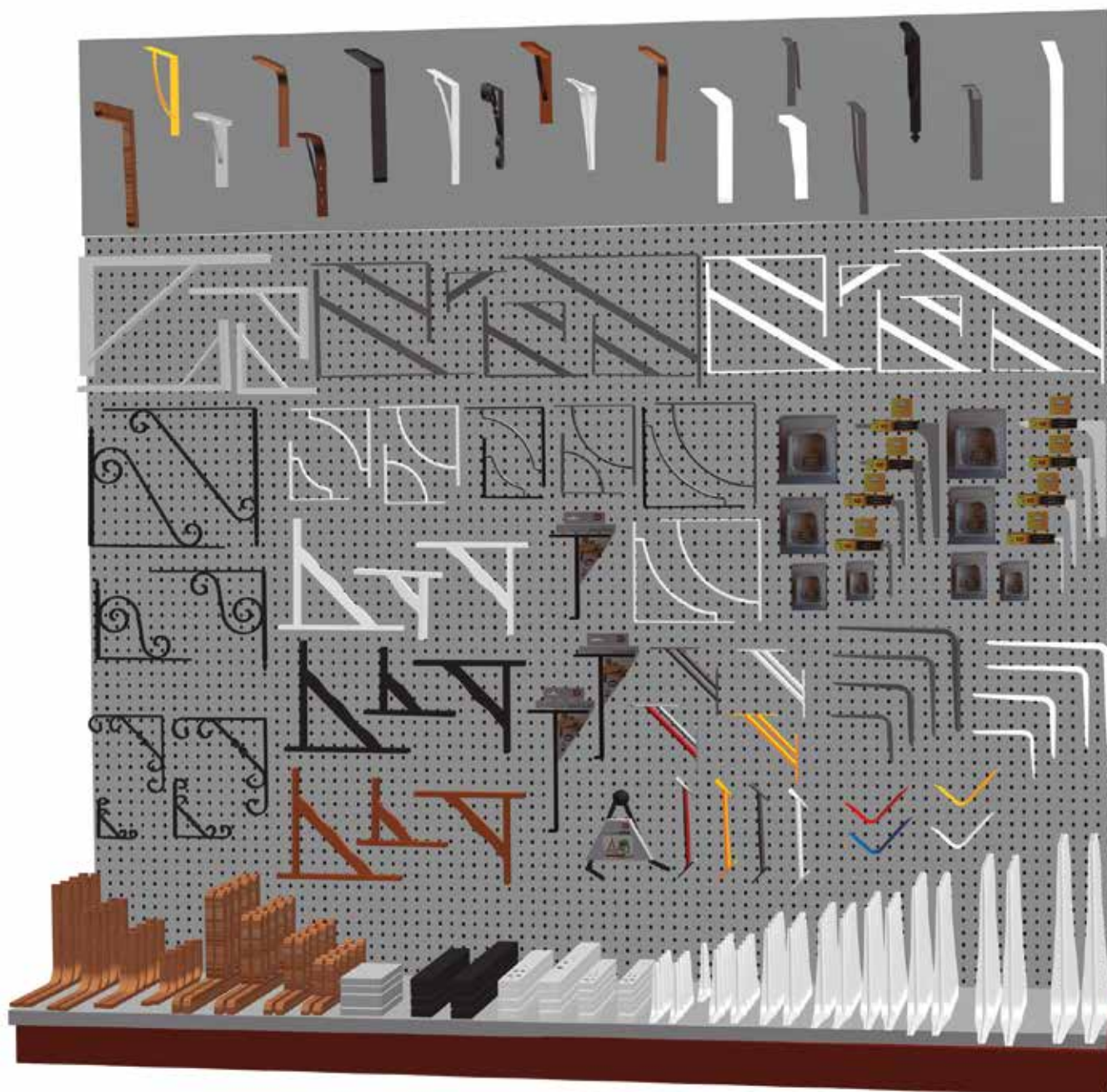



Implantación Escuadras
 Implantation Équerres
 Brackets Implantation

Ref. E6.

300	40	200

- Góndola y panel no incluidos.
- Gondole et panneau pas compris.
- Stand and panel non included.

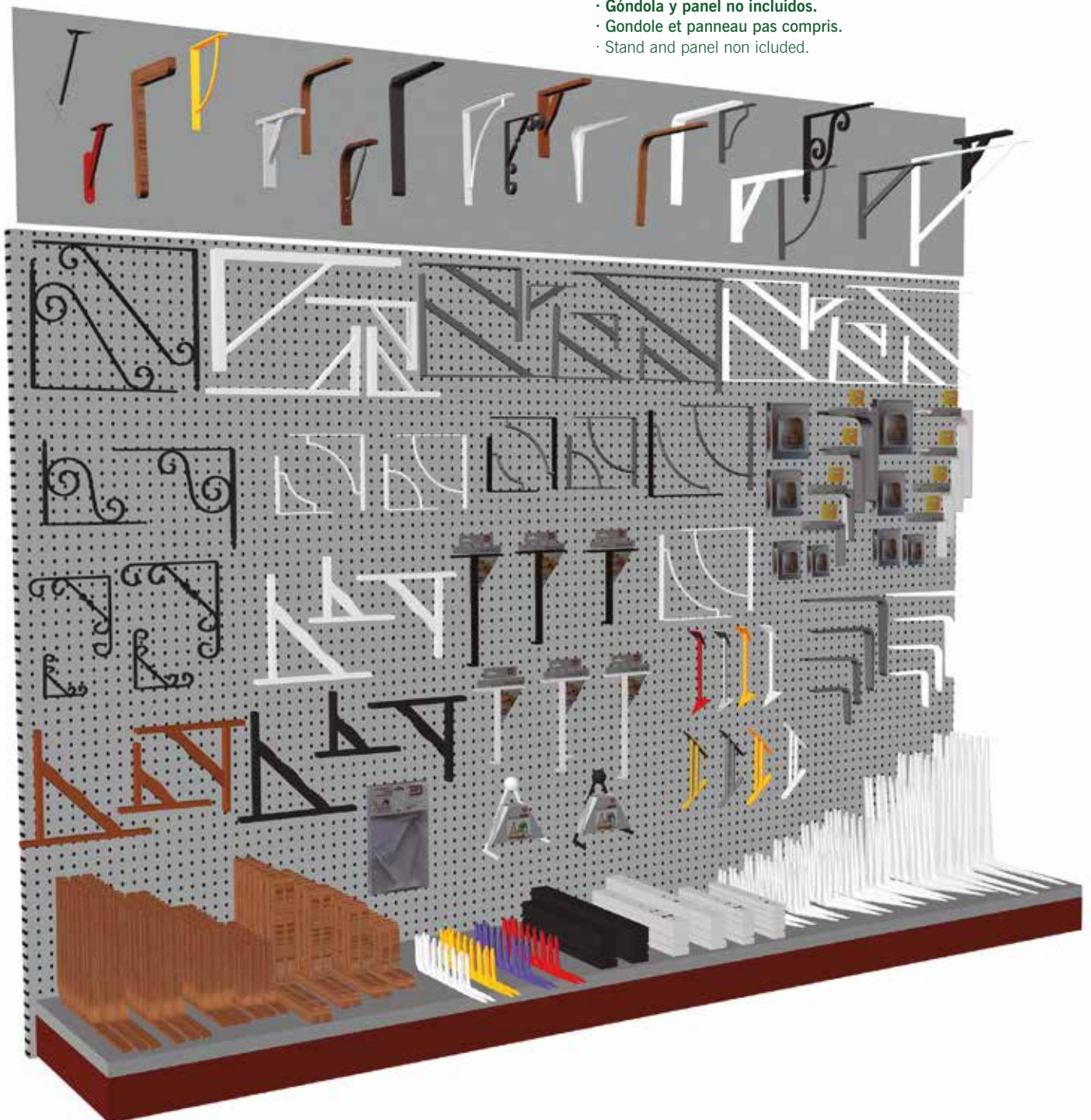



Implantación Soportes Electrodomésticos
 Implantation Supports électroménagers
 Electrical appliance supports Implantation



Ref. LB-1.

100	40	200

- Góndola no incluida. Cartelería incluida.
- Gondole pas compris Affiche compris.
- Stand not included. Poster included.



Implantación Soportes Electrodomésticos
 Implantation Supports électroménagers
 Electrical appliance supports Implantation

Ref. LB-2.

130	40	200

- Góndola no incluida. Cartelería incluida.
- Gondole pas compris Affiche compris.
- Stand not included. Poster included.



Implantación Soportes Electrodomésticos
 Implantation Supports électroménagers
 Electrical appliance supports Implantation



Ref. LB-3.

200	40	200

- Góndola no incluida. Cartelería incluida.
- Gondole pas compris Affiche compris.
- Stand not included. Poster included.



Implantación estantes de madera, cristal y soportes
 Implantation Clips, Équerres décoratives, tablettes en verre et bois
 Wooden and glass shelves and supports Implantation

Ref. HD1-1.

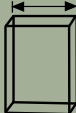
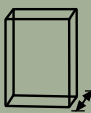
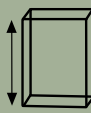
			
100	40	200	

- * Góndola no incluida. Tijas para estantes y cartelería incluidas.
- * Gondole pas compris. Broches pour tablettes et affichage compris.
- * Stand not included. Hocks for shelves and poster included.





Implantación estantes de madera, cristal y soportes
 Implantation Clips, Équerres décoratives, tablettes en verre et bois
 Wooden and glass shelves and supports Implantation

Ref. HD1-2.

cm	cm	cm
130	40	200

- * Góndola no incluida. Tijas para estantes incluidas.
- * Gondole pas compris. Broches pour tablettes compris.
- * Stand not included. Hocks for shelves included.

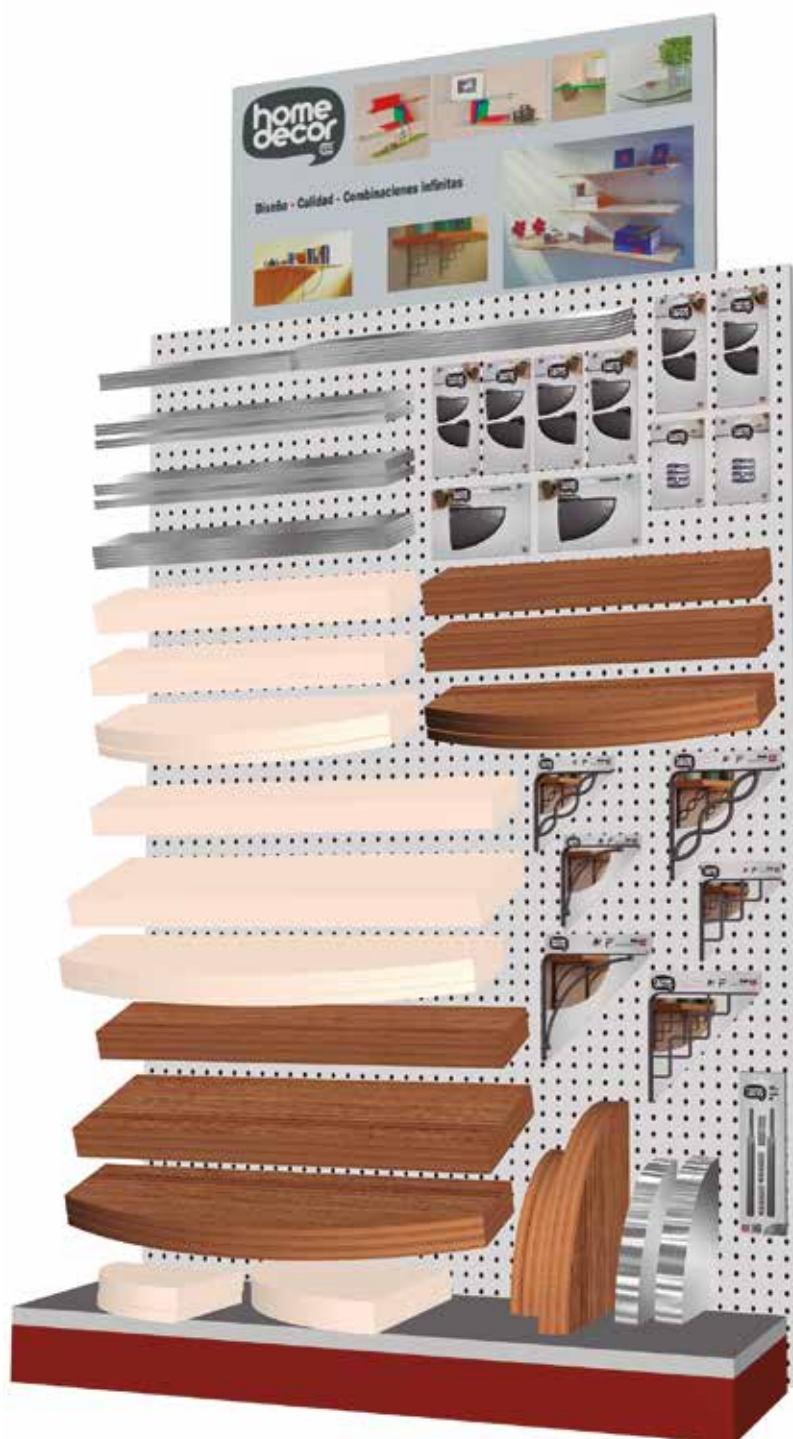

Implantación estantes de madera, cristal y soportes
 Implantation Clips, Équerres décoratives, tablettes en verre et bois
 Wooden and glass shelves and supports Implantation

Ref. HD1-3.

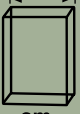
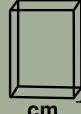
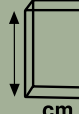
 cm	 cm	 cm	
200	40	200	

- * Góndola no incluida. Tijas para estantes y cartelería incluidas.
- * Gondole pas compris. Broches pour tablettes et affichage compris.
- * Stand not included. Hocks for shelves and poster included.





Implantación estantes de madera, cristal y soportes
 Implantation Clips, Équerres décoratives, tablettes en verre et bois
 Wooden and glass shelves and supports Implantation

Ref. HD1-4.

cm	cm	cm
260	40	200

- * Góndola no incluida. Tijas para estantes y cartelería incluidas.
- * Gondole pas compris. Broches pour tablettes et affichage compris.
- * Stand not included. Hocks for shelves and poster included.



Implantación estantes de madera, cristal y soportes
 Implantation Clips, Équerres décoratives, tablettes en verre et bois
 Wooden and glass shelves and supports Implantation

Ref. HD1-5.

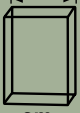
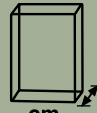
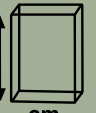
			
cm	cm	cm	
300	40	200	

- * Góndola no incluida. Tijas para estantes y cartelera incluidas.
- * Gondole pas compris. Broches pour tablettes et affichage compris.
- * Stand not included. Hocks for shelves and poster included.



Implantación estantes de fijación invisible
 Tablettes de fixation invisible
 Invisible fixing shelves

Ref. HD2-1.

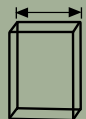
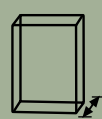
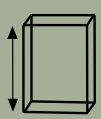
 cm	 cm	 cm	
100	40	200	

- * Góndola y panel no incluidas. Tijas para estantes incluidas.
- * Gondole et panneau pas compris. Broches pour tablettes compris.
- * Stand and panel not included. Hocks for shelves included.





Implantación estantes de fijación invisible

Tablettes de fixation invisible

Invisible fixing shelves

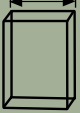
Ref. HD2-2.

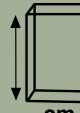
			
cm	cm	cm	
130	40	200	

- * Góndola y panel no incluidos. Tijas para estantes incluidas.
- * Gondole et panneau pas compris. Broches pour tablettes compris.
- * Stand and panel non included. Hocks for shelves included.



Implantación estantes de fijación invisible
 Tablettes de fixation invisible
 Invisible fixing shelves

Ref. HD2-3.

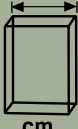
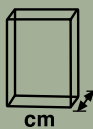
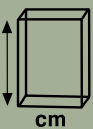
			
cm	cm	cm	
200	40	200	

- * Góndola y panel no incluidos. Tijas para estantes incluidas.
- * Gondole et panneau pas compris. Broches pour tablettes compris.
- * Stand and panel non included. Hocks for shelves included.



Implantación estantes de fijación invisible
 Tablettes de fixation invisible
 Invisible fixing shelves

Ref. HD2-4.

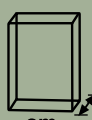
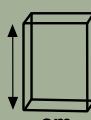
			
cm	cm	cm	
260	40	200	

- * Góndola y panel no incluidos. Tijas para estantes incluidas.
- * Gondole et panneau pas compris. Broches pour tablettes compris.
- * Stand and panel non included. Hocks for shelves included.





Implantación estantes de fijación invisible
 Tablettes de fixation invisible
 Invisible fixing shelves

Ref. HD2-5.

cm	cm	cm	
300	40	200	

- * Góndola y panel no incluidos. Tijas para estantes incluidas.
- * Gondole et panneau pas compris. Broches pour tablettes compris.
- * Stand and panel non included. Hocks for shelves included.



Implantación estantes de fijación invisible
 Tablettes de fixation invisible
 Invisible fixing shelves

Ref. HD2-6.

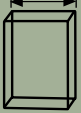
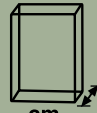
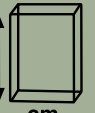
		
cm	cm	cm
360	40	200

- * Góndola y panel no incluidos. Tijas para estantes incluidas.
- * Gondole et panneau pas compris. Broches pour tablettes compris.
- * Stand and panel non included. Hocks for shelves included.



Implantación estantes de fijación invisible
 Tablettes de fixation invisible
 Invisible fixing shelves

Ref. HD2-7.

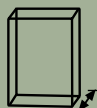
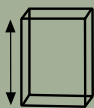
		
cm	cm	cm
400	40	200



- * Góndola y panel no incluidos. Tijas para estantes incluidas.
- * Gondole et panneau pas compris. Broches pour tablettes compris.
- * Stand and panel non included. Hocks for shelves included.



CombiSystem

Implantación Combi-System
 Implantation Combi-System
 Combi-System Concession

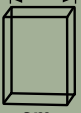
Ref. CS-1 MIX. Simple & Doble.

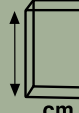
		
100	40	200

- Góndola no incluida. Cartelería incluida.
- Gondole pas compris Affichage compris.
- * Stand non icluded. Poster included

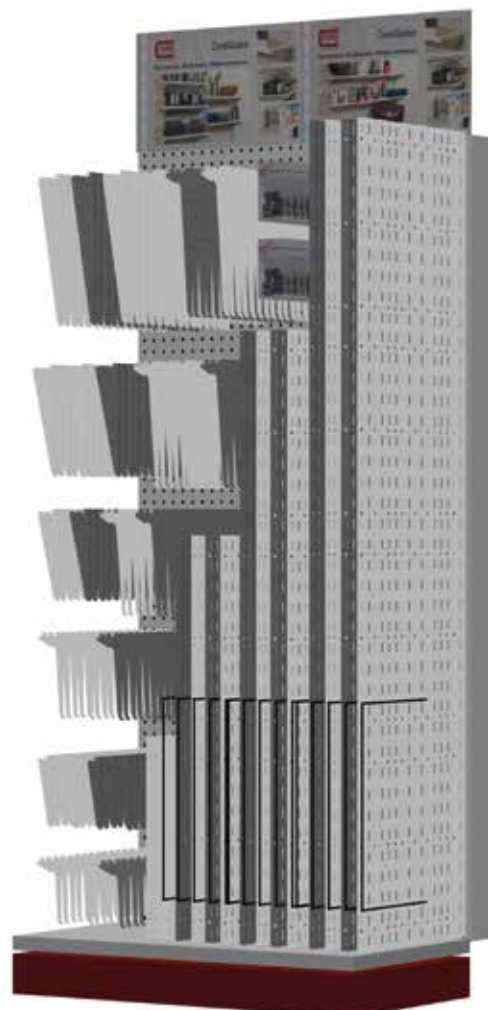
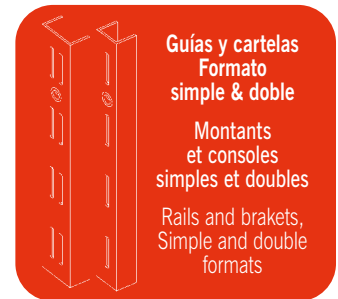
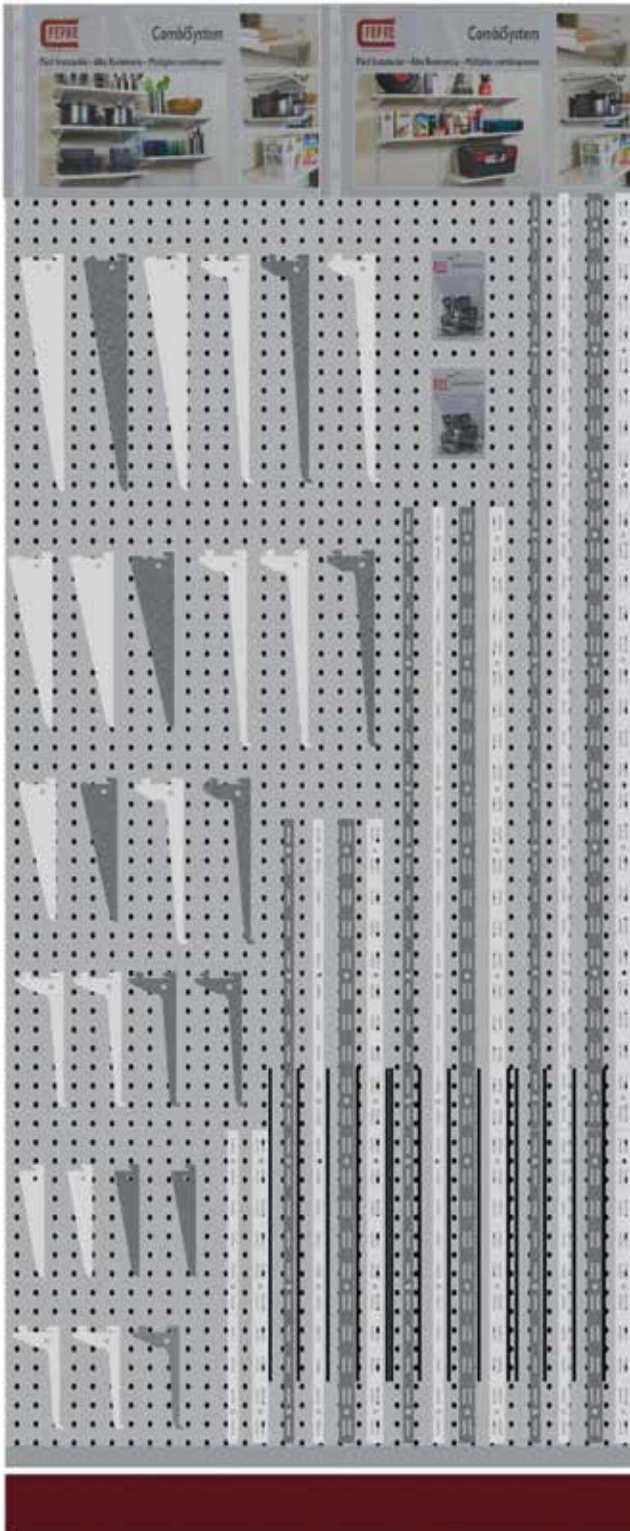

Implantación Combi-System
 Implantation Combi-System
 Combi-System Concession

CombiSystem

Ref. CS-13 MIX. Simple & Doble.

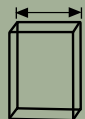
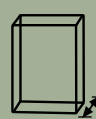
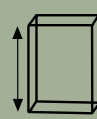
		
130	40	200

- Góndola no incluida. Cartelería incluida.
- Gondole pas compris Affichage compris.
- * Stand non inclued. Poster included



Guías y cartelas
 Formato
 simple & doble

Montants
 et consoles
 simples et doubles

Rails and brackets,
 Simple and double
 formats

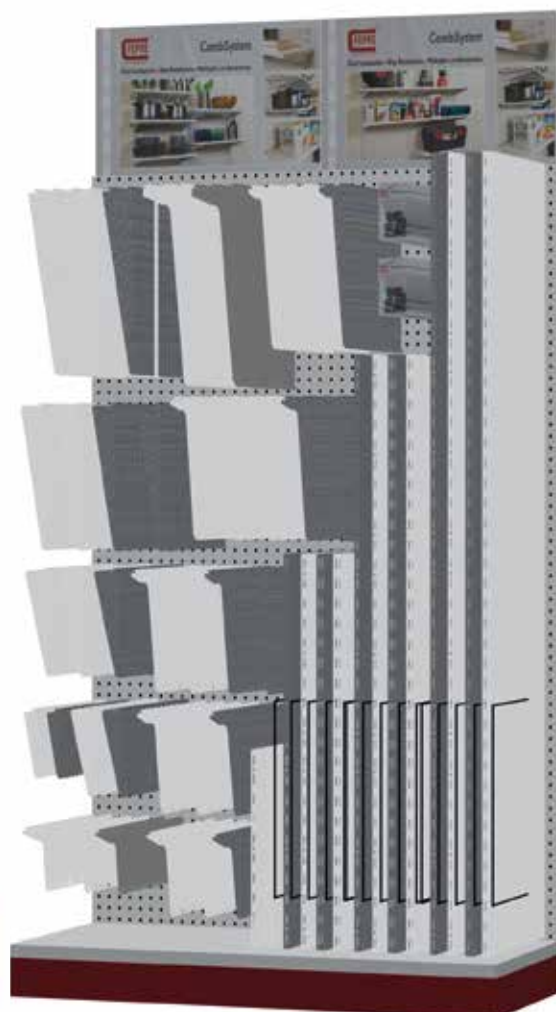



CombiSystem

Implantación Combi-System
 Implantation Combi-System
 Combi-System Concession

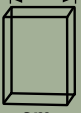

Ref. CS-D. Doble.

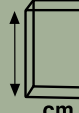
			
65	40	200	

- Expositor y panel incluidos.
- Présentoir et affichage compris.
- Displays and poster included.

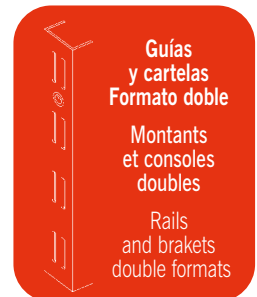

Implantación Combi-System
 Implantation Combi-System
 Combi-System Concession

CombiSystem

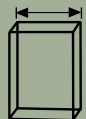
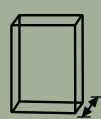
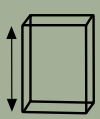

Ref. CS-S. Simple.

 cm	 cm	 cm
65	40	200

- Expositor y panel incluidos.
- Présentoir et affichage compris.
- Displays and poster included.

Guías
y cartelas
Formato simple

Montants
et consoles
simples

Rails
and brakets
simple formats

Implantación Patas
 Implantation Pieds
 Legs Implantation

Ref. PT-1.

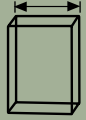
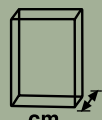
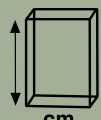

		
100	40	200

- Góndola no incluida. Soportes para patas y cartelería incluidos.
- Gondole pas compris. Supports pour pieds et affichage compris.
- Stand non included. Hocks for legs and poster included.

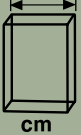

Implantación Patas
 Implantation Pieds
 Legs Implantation

Ref. PT-2.

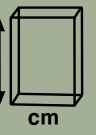
			
130	40	200	

- Góndola no incluida. Soportes para patas y cartelería incluidos.
- Gondole pas compris. Supports pour pieds et affichage compris.
- Stand non icluded. Hocks for legs and poster included.

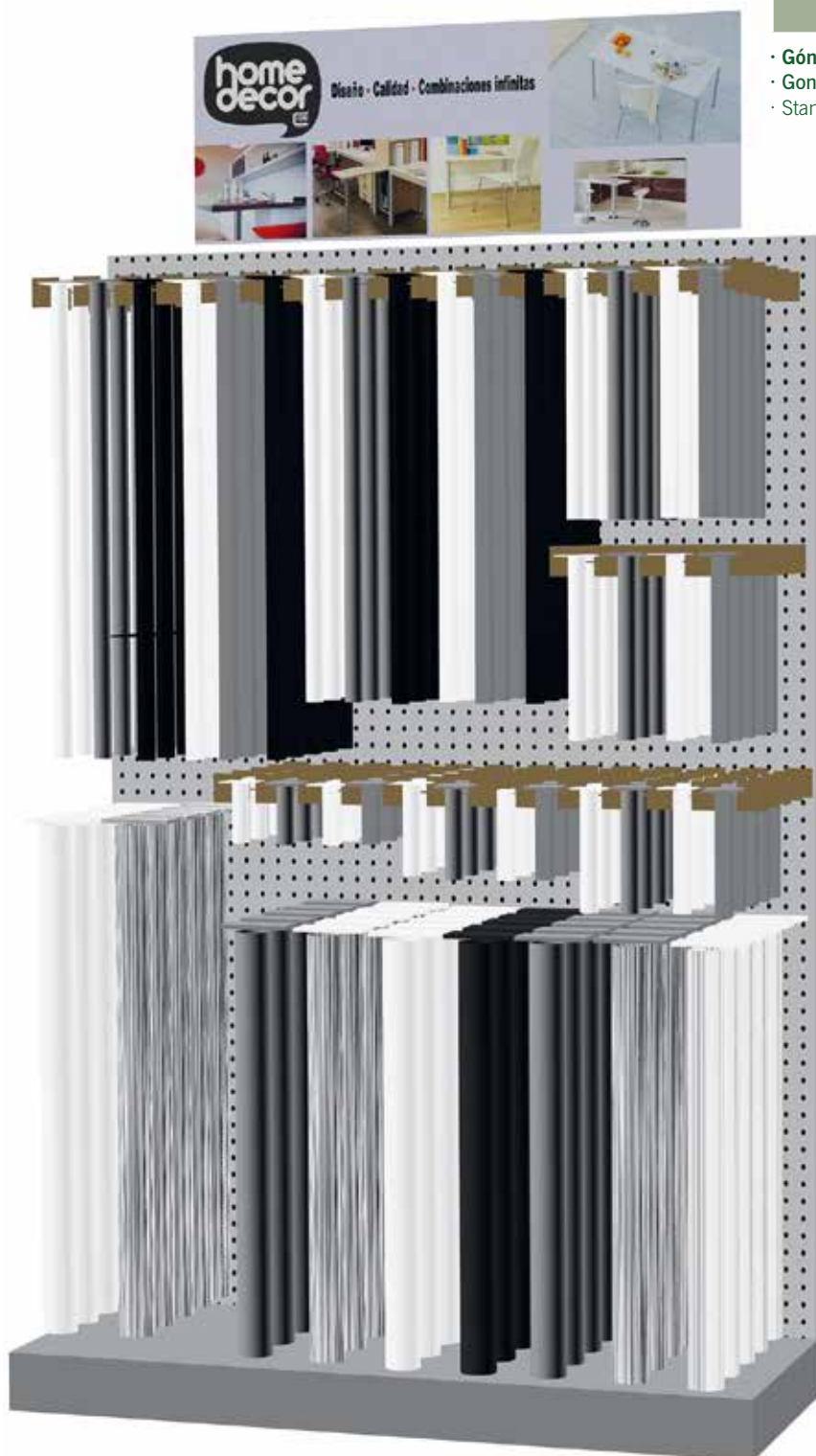

TERMINOS Y CONDICIONES

Precios

- Serán vigentes a partir del 1 de Abril de 2021.
- Esta tarifa podrá modificarse sin previo aviso.
- Los precios indicados son en EUROS y no incluyen IVA.

Transporte

- No podemos aceptar pedidos inferiores a 120,00 €.
- Portes pagados y enviados por nuestros medios hasta:
 - España Peninsular: 250 € mínimo.
 - Archipiélago Balear: 310 € mínimo
 - Para pedidos de exportación: consultar con nuestro Dpto. Comercial.

Acondicionamientos

- En esta tarifa se exponen las unidades por caja / paquete / envase de cada artículo. Rogamos que adapten sus pedidos a dichas unidades de envasado con la finalidad de agilizar la preparación.

Devoluciones

- FEPRE no aceptará bajo ningún concepto cualquier devolución gestionada unilateralmente por el Cliente.
- Toda devolución se deberá acordar previamente con nuestro representante/delegado en la zona o en todo caso con nuestro Dpto. Comercial.
- FEPRE debe interpretar que todo bulto aceptado por nuestro Cliente está libre de rotura, salvo que se indique alguna incidencia en el albarán de transportista. Sólo así FEPRE podrá responsabilizar a la agencia de transportes de los daños ocasionados a la mercancía.
- Cualquier abono por devolución pactada será efectuado por FEPRE, descontando el valor de material en mal estado, los gastos bancarios que haya podido ocasionar, así como los logísticos.
- Para evitar problemas contables rogamos que el Cliente no se descuente el importe hasta recibir el abono por nuestra parte.

FEPRE agradece la confianza depositada en los fabricantes nacionales.

TERMES ET CONDITIONS

Prix

- Seran effectives à partir du 1 Avril 2021.
- Ce tarif peu changer sans préavis.
- Les prix indiqués sont en euros et hors IVA.

Transport

- Nous ne pouvons pas accepter les commandes inférieures à 120,00 €.
- Ports payes par envoi à:
 - Espagne péninsulaire: 250 minimum.
 - Baléares 310 minimum.
 - Pour les commandes à l'exportation: s'il vous plaît contacter notre Département Commercial.

Conditionnement

- Vous trouverez sur ce tarif les unités par boîte / colis de chaque produit. S'il vous plaît, ajuster leurs ordres aux unités d'emballage afin d'accélérer la préparation.

Retours

- FEPRE n'acceptera pas en aucun cas un retour géré unilatéralement par le Client.
- Tous les retours doivent être confirmés par notre représentant / délégué dans la région ou avec notre département commercial.
- FEPRE estime que chaque colis accepté par nôtres clients est libre de casse, à moins d'indication sur le bon de livraison du transporteur. C'est alors seulement que FEPRE peut demander au transporter responsabilités pour les dommages causés.
- Dans tout abonnement pour retour de marchandise accepté, FEPRE déduira la valeur du matériel en mauvais état, les frais bancaires occasionnés, et aussi les frais de la logistique.
- Pour éviter les problèmes de comptabilité nous vous prions de ne pas vous déduire la valeur du retour jusqu'à ce que vous recevez notre paiement.

FEPRE remercie la confiance déposée dans les fabricants nationaux.

TERMS & CONDITIONS

Prices

- Prices will be valid from the April 1, 2021 onwards.
- Current rates might be modified without notice.
- Prices are in EUROS and are exclusive of VAT.

Transport

- We are unable to accept orders of less than € 120,00.
- Free delivery with our courier from:
 - Mainland Spain: from € 250.
 - Balearic Islands: from € 310.
 - Please contact our Sales Department for other export areas.

Conditioning

- Units per box/package of each article are stated along with the price. In order to speed up the assembling, we request orders be conformed to packaging units.

Returns

- FEPRE will not, under any circumstances, accept returns unilaterally arranged for by the customer.
- All returns must be previously agreed with the relevant area manager or, in any case, with our Sales Department.
- All parcels accepted by the customer are understood by FEPRE to be undamaged unless the contrary is stated on the delivery note. This is the only way the courier will take responsibility for any damage caused during transport.
- All agreed returns will be reimbursed by FEPRE after deducting the amount for the damaged goods, bank charges and postage, if applicable.
- To avoid possible accounting issues, we ask our customers to not deduct any amount until a credit note issued by us is received.

FEPRE is proud to trust national manufacturers.

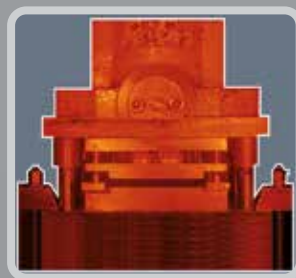
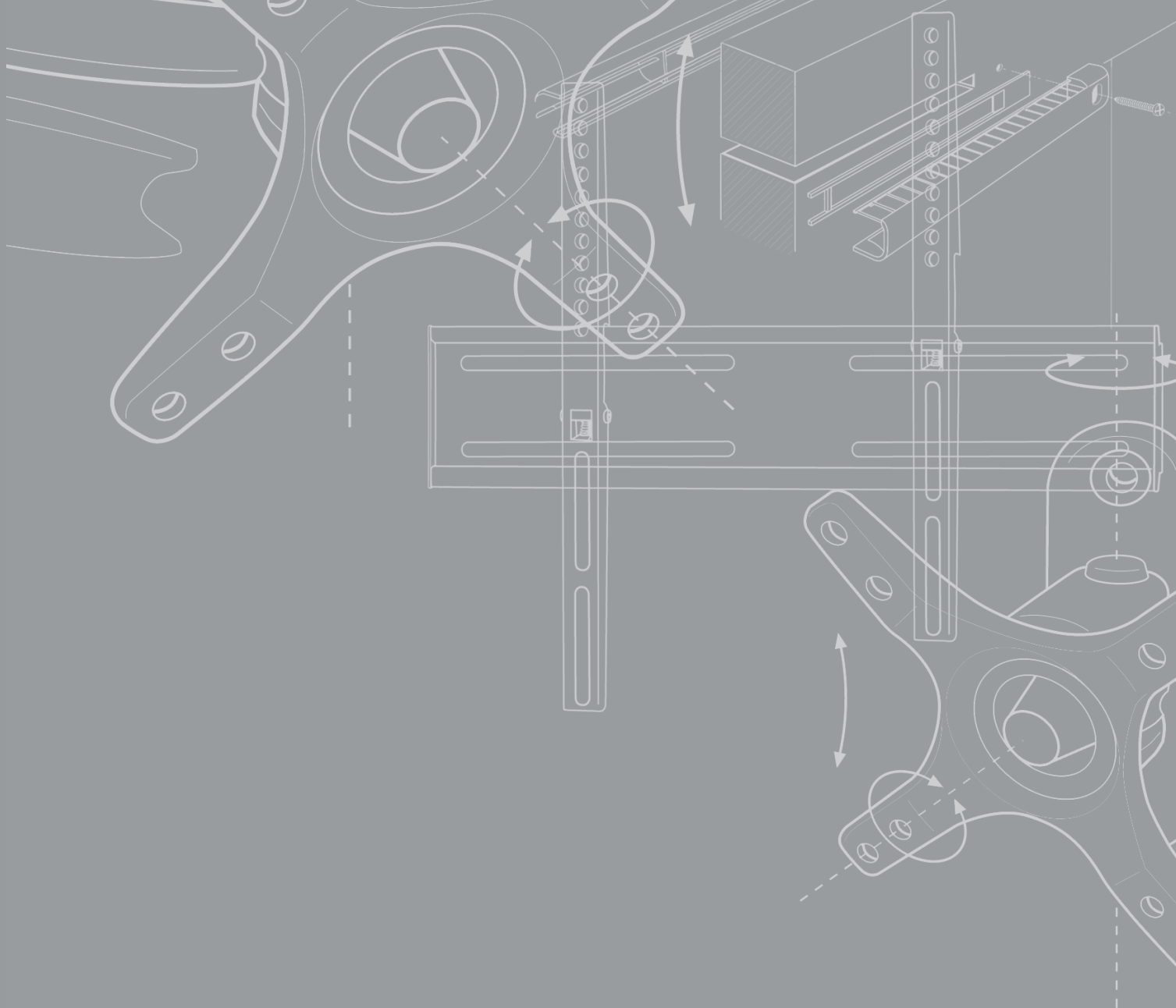

Ferretería y Prensas, S.A.

Polígono Ind. Can Jardí. C/ Schubert, Naves 9 a 11
Apartado de correos 91 - 08191 RUBÍ (Barcelona)
Tel: +34 93 697 01 03 - Fax: + 34 93 588 42 84
pedidos@fepre.com - atencionalcliente@fepre.com

